

High hFE
LOW VCE (sat)

2SC3852/3852A

Silicon NPN Epitaxial Planar Transistor

Application : Driver for Solenoid and Motor, Series Regulator and General Purpose

Absolute maximum ratings (Ta=25°C)

Symbol	2SC3852	2SC3852A	Unit
V _{CB0}	80	100	V
V _{CEO}	60	80	V
V _{EB0}	6		V
I _C	3		A
I _B	1		A
P _C	25(T _C =25°C)		W
T _J	150		°C
T _{stg}	-55 to +150		°C

Electrical Characteristics (Ta=25°C)

Symbol	Conditions	2SC3852	2SC3852A	Unit
I _{CB0}	V _{CB} =	80	100	μA
I _{EB0}	V _{EB} =6V	100max		μA
V _{(BR)CEO}	I _C =25mA	60min	80min	V
h _{FE}	V _{CE} =4V, I _C =0.5A	500min		
V _{CE(sat)}	I _C =2A, I _B =50mA	0.5max		V
f _T	V _{CE} =12V, I _E =-0.2A	15typ		MHz
C _{OB}	V _{CB} =10V, f=1MHz	50typ		pF

External Dimensions FM20(TO220F)

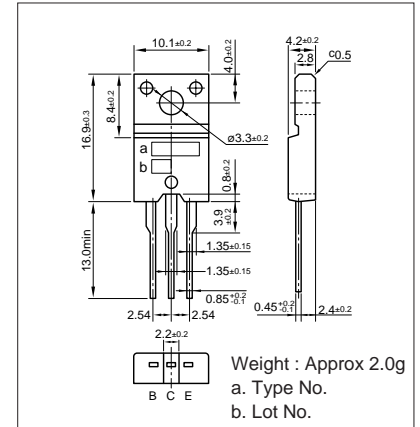

Typical Switching Characteristics (Common Emitter)

V _{CC} (V)	R _L (Ω)	I _C (A)	V _{BB1} (V)	V _{BB2} (V)	I _{B1} (mA)	I _{B2} (mA)	t _{on} (μs)	t _{stg} (μs)	t _f (μs)
20	20	1.0	10	-5	15	-30	0.8typ	3.0typ	1.2typ

I_C-V_{CE} Characteristics (Typical)

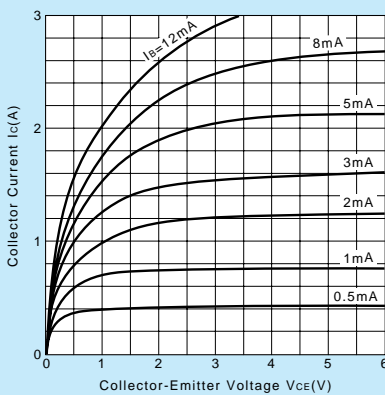

V_{CE(sat)}-I_B Characteristics (Typical)

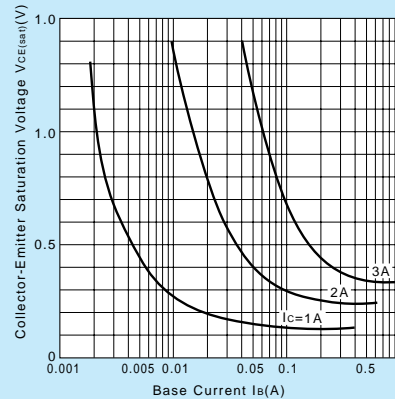

I_C-V_{BE} Temperature Characteristics (Typical)

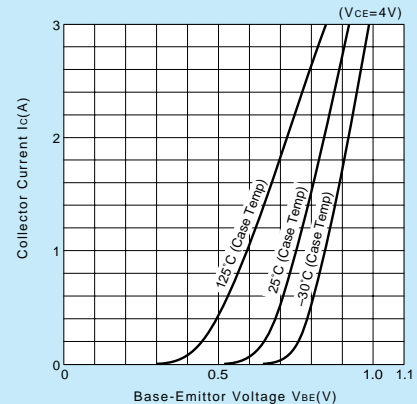

h_{FE}-I_C Characteristics (Typical)

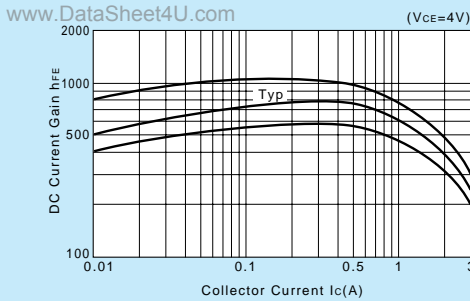

h_{FE}-I_C Temperature Characteristics (Typical)

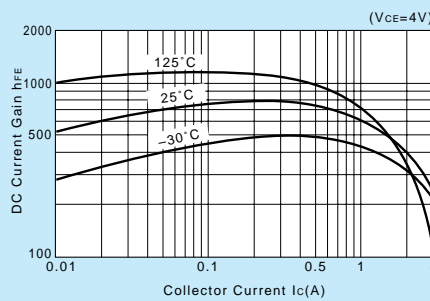

θ_{j-a-t} Characteristics

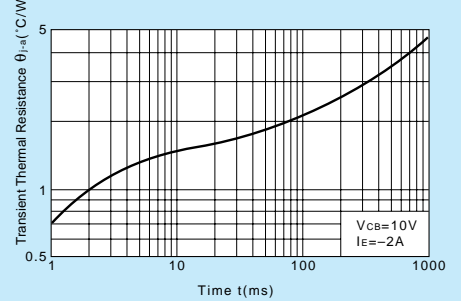

f_T-I_E Characteristics (Typical)

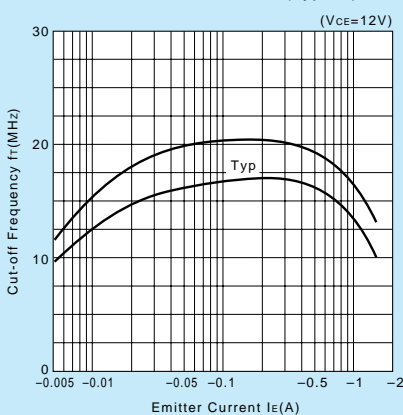

Safe Operating Area (Single Pulse)

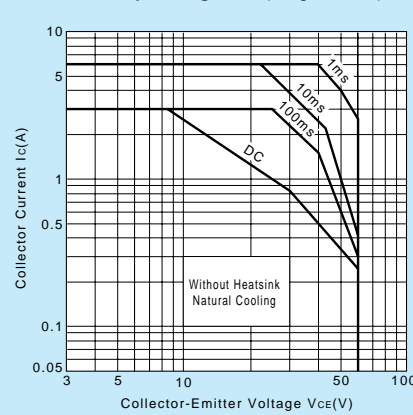

P_C-T_a Derating

