



# BD677/A/679/A/681 BD678/A/680/A/682

## COMPLEMENTARY SILICON POWER DARLINGTON TRANSISTORS

- STMicroelectronics PREFERRED SALESTYPES
- COMPLEMENTARY PNP - NPN DEVICES
- MONOLITHIC DARLINGTON CONFIGURATION
- INTEGRATED ANTIPARALLEL COLLECTOR-EMITTER DIODE

### APPLICATION

- LINEAR AND SWITCHING INDUSTRIAL EQUIPMENT

### DESCRIPTION

The BD677, BD677A, BD679, BD679A and BD681 are silicon epitaxial-base NPN power transistors in monolithic Darlington configuration mounted in Jedec SOT-32 plastic package.

They are intended for use in medium power linear and switching applications

The complementary PNP types are BD678, BD678A, BD680, BD680A and BD682 respectively.

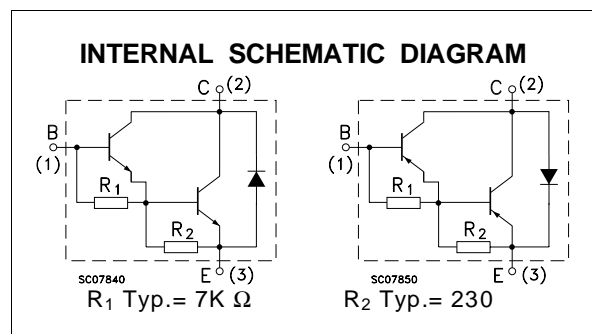
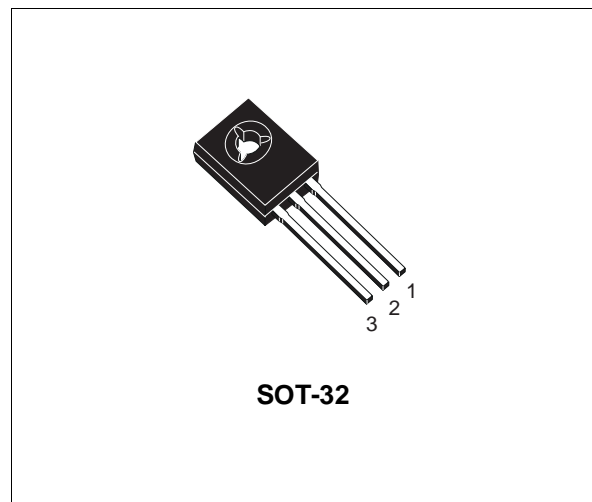

### ABSOLUTE MAXIMUM RATINGS

Symbol	Parameter	Value			Unit	
		NPN	BD677/A	BD679/A		BD681
		PNP	BD678/A	BD680/A	BD682	
V <sub>CB0</sub>	Collector-Base Voltage (I <sub>E</sub> = 0)		60	80	100	V
V <sub>CE0</sub>	Collector-Emitter Voltage (I <sub>B</sub> = 0)		60	80	100	V
V <sub>EB0</sub>	Emitter-Base Voltage (I <sub>C</sub> = 0)		5			V
I <sub>C</sub>	Collector Current		4			A
I <sub>CM</sub>	Collector Peak Current		6			A
I <sub>B</sub>	Base Current		0.1			A
P <sub>tot</sub>	Total Dissipation at T <sub>c</sub> ≤ 25 °C		40			W
T <sub>stg</sub>	Storage Temperature		-65 to 150			°C
T <sub>j</sub>	Max. Operating Junction Temperature		150			°C

For PNP types voltage and current values are negative.

# BD677/677A/678/678A/679/679A/680/680A/681/682

## THERMAL DATA

R <sub>thj-case</sub>	Thermal Resistance Junction-case	Max	3.12	°C/W
R <sub>thj-amb</sub>	Thermal Resistance Junction-ambient	Max	100	°C/W

## ELECTRICAL CHARACTERISTICS (T<sub>case</sub> = 25 °C unless otherwise specified)

Symbol	Parameter	Test Conditions	Min.	Typ.	Max.	Unit
I <sub>CBO</sub>	Collector Cut-off Current (I <sub>E</sub> = 0)	V <sub>CE</sub> = rated V <sub>CBO</sub> V <sub>CE</sub> = rated V <sub>CBO</sub> T <sub>C</sub> = 100 °C			0.2 2	mA mA
I <sub>CEO</sub>	Collector Cut-off Current (I <sub>B</sub> = 0)	V <sub>CE</sub> = half rated V <sub>CEO</sub>			0.5	mA
I <sub>EBO</sub>	Emitter Cut-off Current (I <sub>C</sub> = 0)	V <sub>EB</sub> = 5 V			2	mA
V <sub>CEO(sus)*</sub>	Collector-Emitter Sustaining Voltage	I <sub>C</sub> = 50 mA for <b>BD677/677A/678/678A</b> for <b>BD679/679A/680/680A</b> for <b>BD681/682</b>	60 80 100			V V V
V <sub>CE(sat)*</sub>	Collector-Emitter Saturation Voltage	for <b>BD677/678/679/680/681/682</b> I <sub>C</sub> = 1.5 A I <sub>B</sub> = 30 mA for <b>BD677A/678A/679A/680A</b> I <sub>C</sub> = 2 A I <sub>B</sub> = 40 mA			2.5 2.8	V V
V <sub>BE*</sub>	Base-Emitter Voltage	for <b>BD677/678/679/680/681/682</b> I <sub>C</sub> = 1.5 A V <sub>CE</sub> = 3 V for <b>BD677A/678A/679A/680A</b> I <sub>C</sub> = 2 A V <sub>CE</sub> = 3 V			2.5 2.5	V V
h <sub>FE*</sub>	DC Current Gain	for <b>BD677/678/679/680/681/682</b> I <sub>C</sub> = 1.5 A V <sub>CE</sub> = 3 V for <b>BD677A/678A/679A/680A</b> I <sub>C</sub> = 2 A V <sub>CE</sub> = 3 V	750 750			
h <sub>fe</sub>	Small Signal Current Gain	I <sub>C</sub> = 1.5 A V <sub>CE</sub> = 3 V f = 1 MHz	1			

\* Pulsed: Pulse duration = 300 ms, duty cycle 1.5 %

## Safe Operating Areas

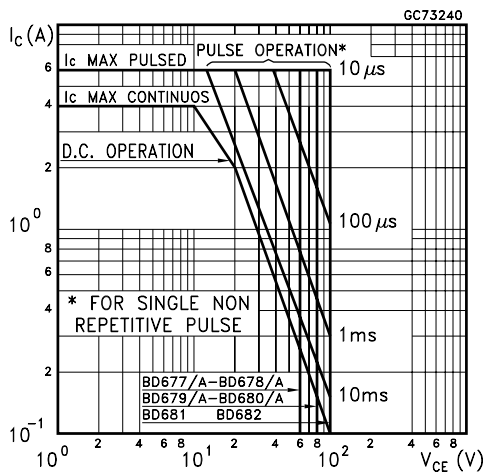

## Derating Curve

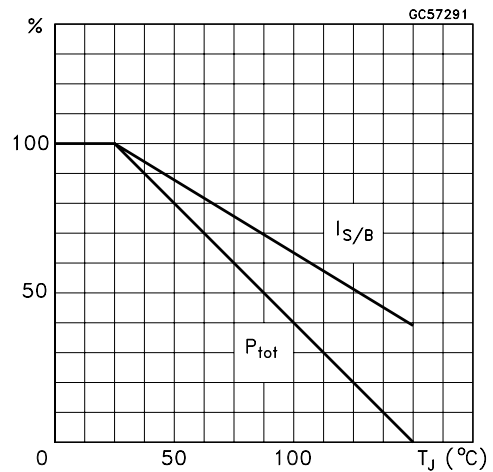

DC Current Gain (NPN type)

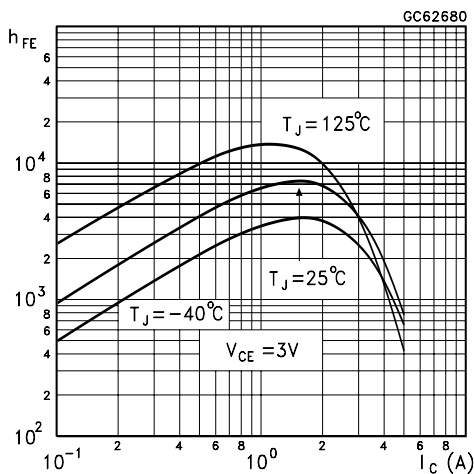

DC Current Gain (PNP type)

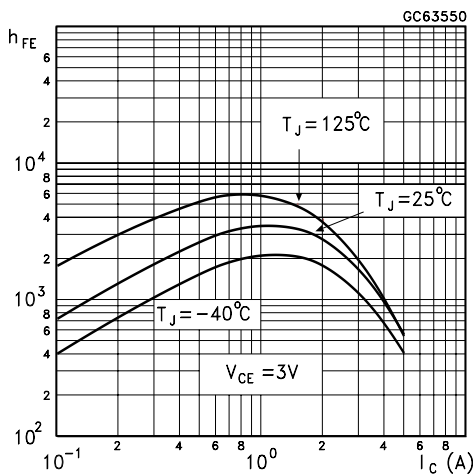

Collector-Emitter Saturation Voltage (NPN type)

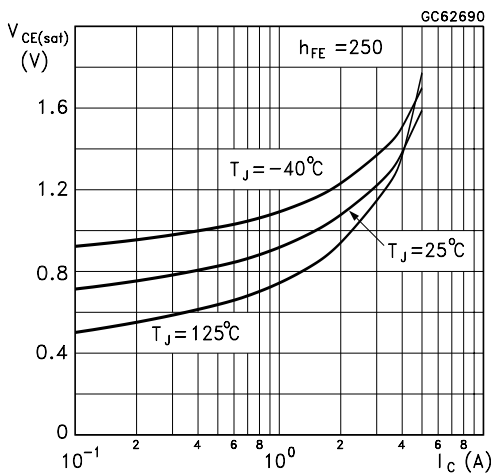

Collector-Emitter Saturation Voltage (PNP type)

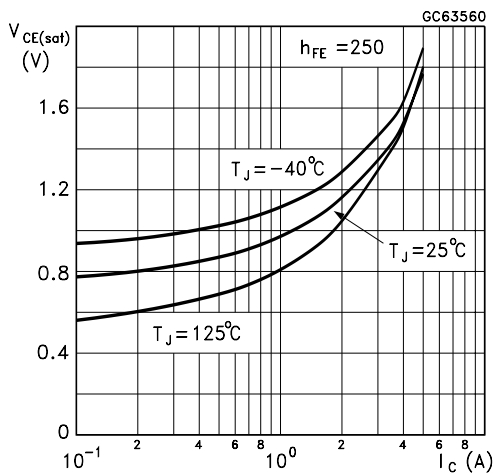

Base-Emitter Saturation Voltage (NPN type)

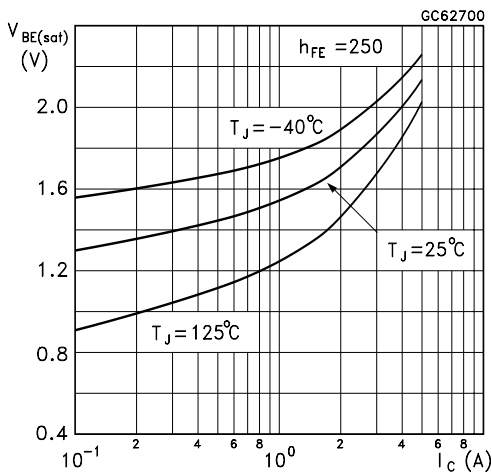

Base-Emitter Saturation Voltage (PNP type)

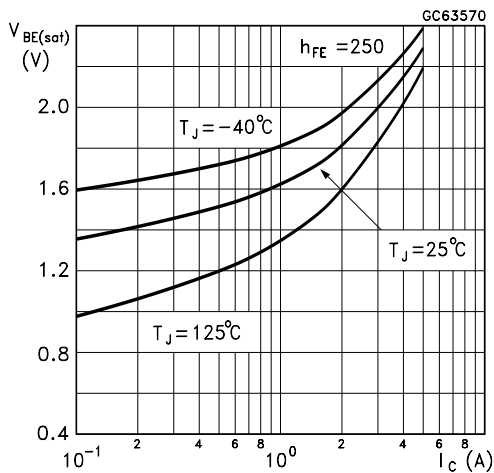

Base-Emitter On Voltage (NPN type)

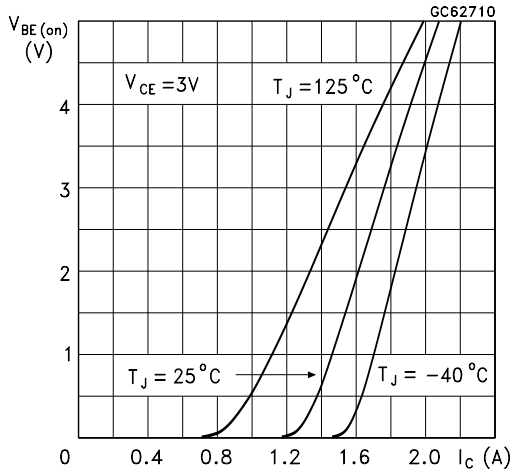

Base-Emitter On Voltage (PNP type)

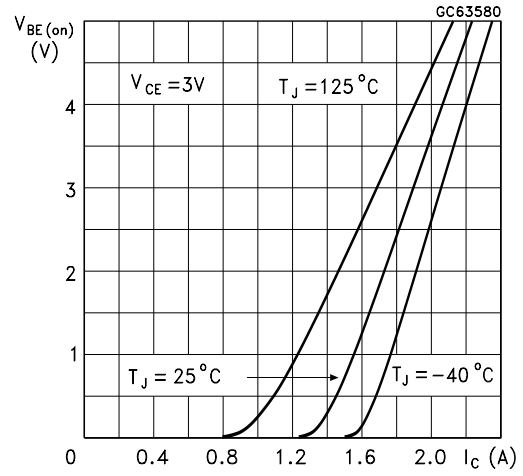

Freewheel Diode Forward Voltage (NPN types)

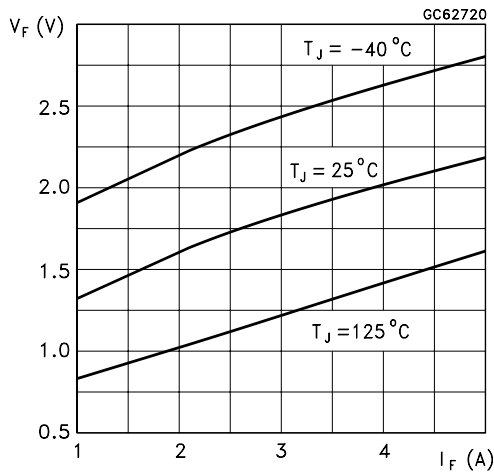

Freewheel Diode Forward Voltage (PNP types)

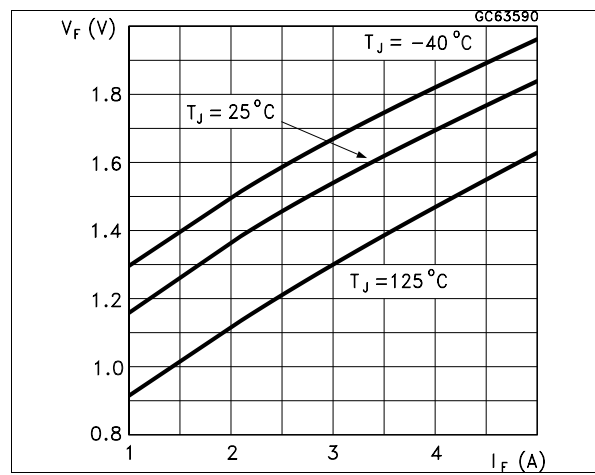

## SOT-32 (TO-126) MECHANICAL DATA

DIM.	mm			inch		
	MIN.	TYP.	MAX.	MIN.	TYP.	MAX.
A	7.4		7.8	0.291		0.307
B	10.5		10.8	0.413		0.445
b	0.7		0.9	0.028		0.035
b1	0.49		0.75	0.019		0.030
C	2.4		2.7	0.040		0.106
c1	1.0		1.3	0.039		0.050
D	15.4		16.0	0.606		0.629
e		2.2			0.087	
e3	4.15		4.65	0.163		0.183
F		3.8			0.150	
G	3		3.2	0.118		0.126
H			2.54			0.100

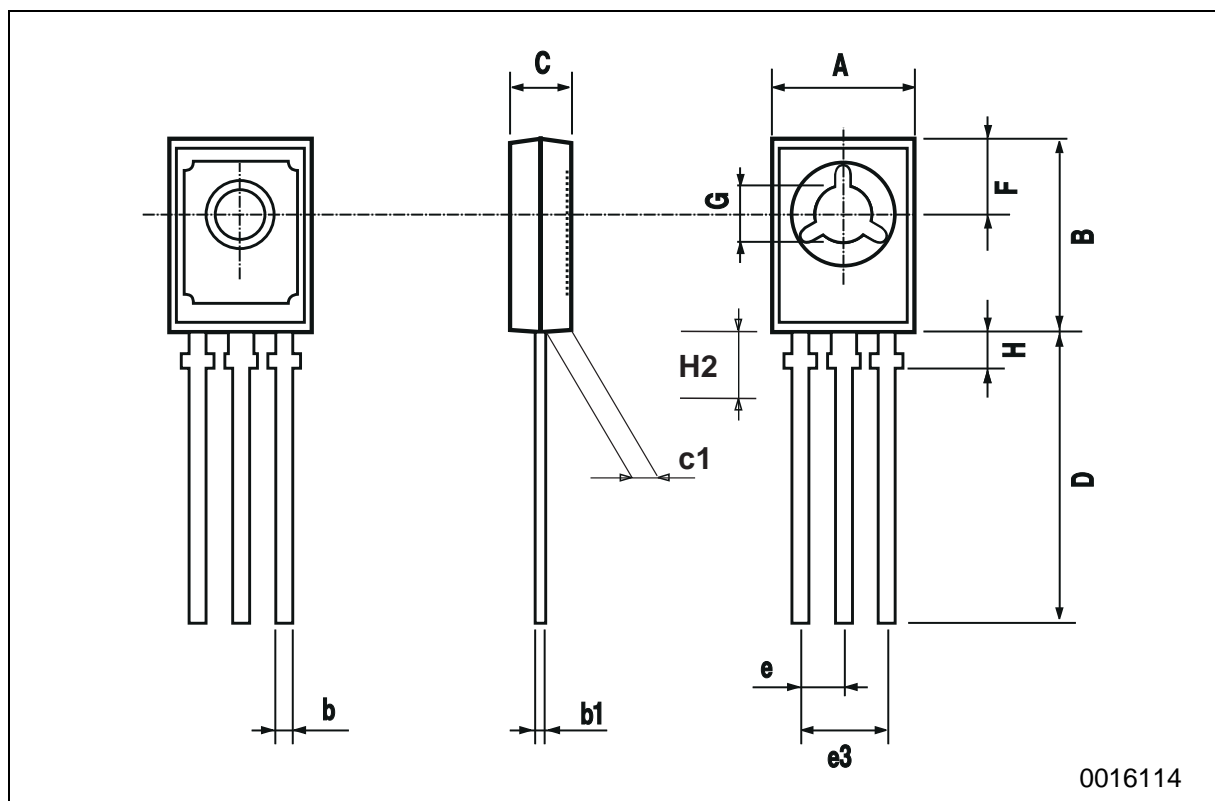

Information furnished is believed to be accurate and reliable. However, STMicroelectronics assumes no responsibility for the consequences of use of such information nor for any infringement of patents or other rights of third parties which may result from its use. No license is granted by implication or otherwise under any patent or patent rights of STMicroelectronics. Specification mentioned in this publication are subject to change without notice. This publication supersedes and replaces all information previously supplied. STMicroelectronics products are not authorized for use as critical components in life support devices or systems without express written approval of STMicroelectronics.

The ST logo is a trademark of STMicroelectronics

© 2000 STMicroelectronics – Printed in Italy – All Rights Reserved

STMicroelectronics GROUP OF COMPANIES

Australia - Brazil - China - Finland - France - Germany - Hong Kong - India - Italy - Japan - Malaysia - Malta - Morocco - Singapore - Spain - Sweden - Switzerland - United Kingdom - U.S.A.

<http://www.st.com>

This datasheet has been download from:

[www.datasheetcatalog.com](http://www.datasheetcatalog.com)

Datasheets for electronics components.