



W83194BR-SD
W83194BG-SD

**Winbond Clock Generator For
INTEL P4 Springdale Series Chipset**

Date: Mar./22/2006 Revision: 1.2

W83194BR-SD/W83194BG-SD



W83194BR-SD/W83194BG-SD Revision history

VERSION	DATE	PAGE	DESCRIPTION
		n.a.	All of the versions before 0.50 are for internal use.
0.5	07/07/03	n.a.	First published preliminary version.
0.6	12/18/03	7~15, 20	Correction IC version, add register default value and correction some description and default value
1.0	05/05/04		Update on web
1.1	4/13/2005	23	Add disclaimer
1.2	12/20/2005		Add Lead-free part number

Please note that all data and specifications are subject to change without notice. All the trademarks of products and companies mentioned in this data sheet belong to their respective owners.

LIFE SUPPORT APPLICATIONS

These products are not designed for use in life support appliances, devices, or systems where malfunction of these products can reasonably be expected to result in personal injury. Winbond customers using or selling these products for use in such applications do so at their own risk and agree to fully indemnify Winbond for any damages resulting from such improper use or sales.

W83194BR-SD/W83194BG-SD



Table of Contents-

1.	GENERAL DESCRIPTION	1
2.	FEATURES	1
3.	PIN CONFIGURATION	2
4.	BLOCK DIAGRAM	2
5.	PIN DESCRIPTION.....	3
5.1	Crystal I/O	3
5.2	CPU, SRC, 3V66, PCI Clock Outputs	3
5.3	Fixed Frequency Outputs	4
5.4	I2C Control Interface.....	4
5.5	Output Control Pins	5
5.6	Power an GND Pins.....	5
6.	FREQUENCY SELECTION BY HARDWARE OR SOFTWARE	6
7.	I ² C CONTROL AND STATUS REGISTERS.....	7
7.1	Register 0: Frequency Select (Default =10H).....	7
7.2	Register 1: SRC/CPU Clock (1 = Enable, 0 = Disable) (Default = E3H)	7
7.3	Register 2: PCI Clock (1 = Enable, 0 = Disable) (Default = FFH)	8
7.4	Register 3: PCI, 3V66 Clock (1 = Enable, 0 = Disable) (Default = EFH).....	8
7.5	Register 4: 24_48 MHz, REF Control (1 = Enable, 0 = Disable) (Default =FCH).....	8
7.6	Register 5: Watchdog Control (Default = 00H).....	9
7.7	Register 6: Watchdog Timer (Default =08H)	10
7.8	Register 7: Asynchronous Program (Default = 40H)	10
7.9	Register 8: M/N Program (Default = 8AH).....	10
7.10	Register 9: M/N Program (Default = CEH)	11
7.11	Register 10: M/N Program (Default = 13H)	11
7.12	Register 11: Spread Spectrum Programming (Default = 2FH).....	11
7.13	Register 12: Divider Ratio (Default = C6H).....	12
7.14	Register 13: Control (Default = 0FH).....	12
7.15	Register 14: Control (Default = 27H)	13
7.16	Register 15: Control (Default =3CH).....	13
7.17	Register 16: Control (Default = 24H)	13
7.18	Register 17: Slew Rate Control (Default = 00H).....	14
7.19	Register 18: Slew Rate Control (Default = 00H).....	14
7.20	Register 19: Control (Default = 0AH).....	15
7.21	Register 20: Winbond Chip ID – Project Code (Ready Only) (Default = 47H)	15

W83194BR-SD/W83194BG-SD



CLOCK GEN. FOR INTEL P4 SPRINGDALE/PRESCOTT SERIES CHIPSET

7.22	Register 21: Reserved (Ready Only) (Default = 50H)	16
8.	ACCESS INTERFACE	17
8.1	Block Write Protocol	17
8.2	Block Read Protocol	17
8.3	Byte Write Protocol	17
8.4	Byte Read Protocol	17
9.	SPECIFICATIONS	18
9.1	Absolute Maximum Ratings	18
9.2	General Operating Characteristics	18
9.3	Skew Group Timing Clock	18
9.4	CPU 0.7V Electrical Characteristics	19
9.5	SRC 0.7V Electrical Characteristics	19
9.6	3V66 Electrical Characteristics	19
9.7	PCI Electrical Characteristics	20
9.8	24M, 48M Electrical Characteristics	20
9.9	REF Electrical Characteristics	20
10.	ORDERING INFORMATION	21
11.	HOW TO READ THE TOP MARKING	21
12.	PACKAGE DRAWING AND DIMENSIONS	22

W83194BR-SD/W83194BG-SD



1. GENERAL DESCRIPTION

The W83194BR-SD is a Clock Synthesizer for Intel P4 Springdale series chipset. W83194BR-SD provides all clocks required for high-speed microprocessor and provides step-less frequency programming and 32 different frequencies of CPU, SRC, PCI, and 3V66 clocks setting. All clocks are externally selectable with smooth transitions.

The W83194BR-SD provides I²C serial bus interface to program the registers to enable or disable each clock outputs and provides +/-0.25%, +/-0.5% center type and -0.5%, -1.0% down type spread spectrum or programmable S.S.T. scale to reduce EMI.

The W83194BR-SD also has watchdog timer and reset output pin to support auto-reset when systems hanging caused by improper frequency setting.

The W83194BR-SD accepts a 14.318 MHz reference crystal as its input and runs on a 3.3V supply.

2. FEATURES

- 2 pairs current mode differential clock for CPU and Chipset
- 1 pairs current mode differential clock for SRC
- 3 3V66 clock outputs
- 1 3V66/VCH clock output default 66MHz
- 9 PCI synchronous clocks, 3 free running
- 2 48MHz clock outputs for USB and DOT
- 1 24_48MHz for I/O chip, default 48MHz
- 3 REF 14.318MHz clock outputs
- SRC/AGP/PCI clock out supports synchronous and asynchronous mode
- 3V66 leads PCICLK from 1.5ns to 3.5ns
- I²C 2-Wire serial interface supports block and byte mode read/write
- Step-less frequency programming
- Smooth frequency switch with selections from 100 to 400MHz
- Programmable clock outputs Slew rate control and Skew control
- +/- 0.25% center type spread spectrum in table mode
- Programmable S.S.T. scale to reduce EMI
- Programmable registers to enable/stop each output and select modes
- Watch Dog Timer and RESET# output pins
- 48-pin SSOP package

W83194BR-SD/W83194BG-SD



3. PIN CONFIGURATION

FS1*/REF0	1	48	VDDA
FS0*/REF1	2	47	GND
REF2	3	46	IREF
VDDREF	4	45	RESET#
XIN	5	44	GND
XOUT	6	43	CPUCLKT1
GND	7	42	CPUCLKC1
FS2*/PCICLK_F0	8	41	VDDCPU
FS4*/PCICLK_F1	9	40	CPUCLKT0
PCICLK_F2	10	39	CPUCLKC0
VDDPCI	11	38	GND
GND	12	37	SRCCCLKT
PCICLK0	13	36	SRCCCLKC
PCICLK1	14	35	VDD
PCICLK2	15	34	VTT_PWRGD/PD#*
PCICLK3	16	33	SDATA*
VDDPCI	17	32	SCLK*
GND	18	31	3V66_0
PCICLK4	19	30	3V66_1
PCICLK5	20	29	GND
SEL24_48#*/24_48MHz	21	28	VDD3V66
FS3*/48MHz_USB	22	27	3V66_2
48MHz_DOT	23	26	3V66_3/VCH/VCH_EN#&
GND	24	25	VDD48

#: Active low

*: Internal pull up resistor 120KΩ to VDD

&: Internal Pull-down resistor 120KΩ to GND

4. BLOCK DIAGRAM

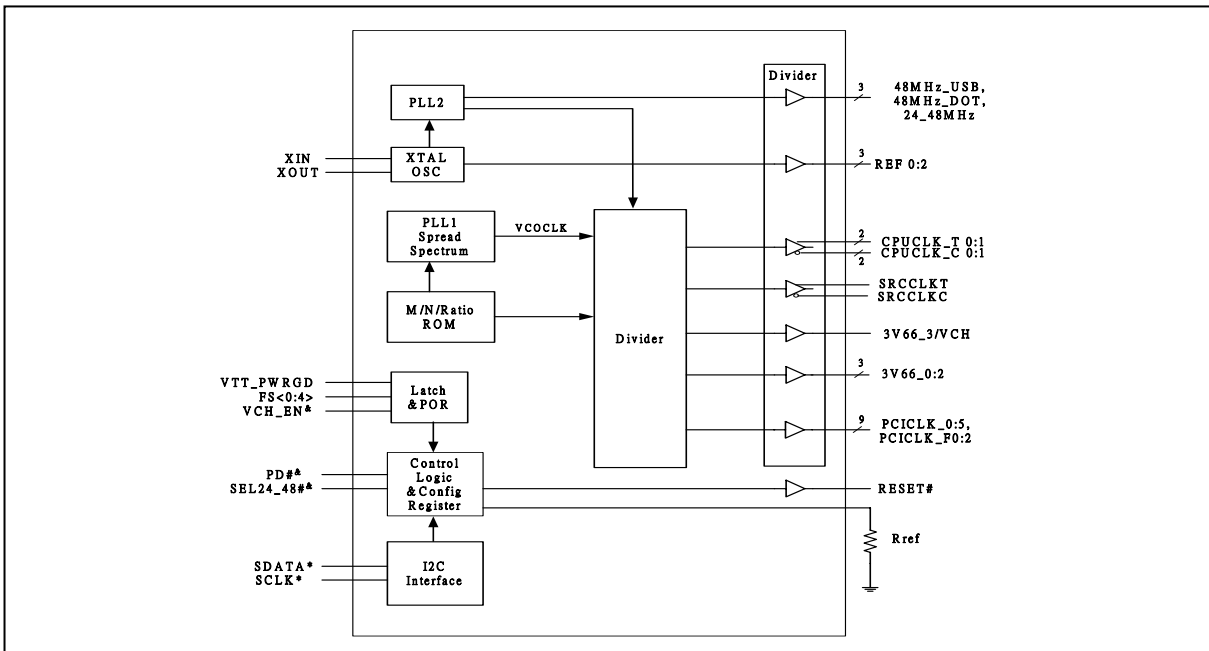

W83194BR-SD/W83194BG-SD



CLOCK GEN. FOR INTEL P4 SPRINGDALE/PRESCOTT SERIES CHIPSET

5. PIN DESCRIPTION

BUFFER TYPE SYMBOL	DESCRIPTION
IN	Input
IN _{td120k}	Latch input pin and internal 120KΩ pull down
IN _{tp120k}	Latch input pin and internal 120KΩ pull up
OUT	Output
OD	Open Drain
I/O	Bi-directional Pin
I/OD	Bi-directional Pin, Open Drain
#	Active Low
*	Internal 120kΩ pull-up
&	Internal 120kΩ pull-down

5.1 Crystal I/O

PIN	PIN NAME	TYPE	DESCRIPTION
5	XIN	IN	Crystal input with internal loading capacitors (18pF) and feedback resistors.
6	XOUT	OUT	Crystal output at 14.318 MHz nominally with internal loading capacitors (18pF).

5.2 CPU, SRC, 3V66, PCI Clock Outputs

PIN	PIN NAME	TYPE	DESCRIPTION
40, 43, 39, 42	CPUCLKT [0:1] CPUCLKC [0:1]	OUT	0.7V Current mode differential clock outputs for CPU and Chipset.
37, 36	SRCCLKT, SRCCLKC	OUT	0.7V Current mode differential clock outputs for Chipset, 100 MHz(default) or 200 MHz outputs selected by I2C register.
26	3V66_3/VCH VCH_EN ^{&}	OUT IN _{td120k}	66 MHz(default) or 48 MHz outputs selected by hardware trapping data on 26 pin VCH_EN ^{&} selecting.
31, 30, 27	3V66_0, 3V66_1, 3V66_2	OUT	3.3V output clocks for the chipset and AGP slot.
8	PCICLK_F0	OUT	PCI clock output.
	FS2 ^{&}	IN _{td120k}	Latched input for FS2 at initial power up for H/W selecting the output frequency clocks. This is internal 120KΩ pull down.

W83194BR-SD/W83194BG-SD



CLOCK GEN. FOR INTEL P4 SPRINGDALE/PRESCOTT SERIES CHIPSET

CPU, SRC, 3V66, PCI Clock Outputs continued

PIN	PIN NAME	TYPE	DESCRIPTION
9	PCICLK7_F1	OUT	PCI clock output.
	FS4 ^{&}	IN _{td120k}	Latched input for FS4 at initial power up for H/W selecting the output frequency clocks. This is internal 120KΩ pull down.
10	PCICLK_F2	OUT	PCI clock outputs.
13, 14, 15, 16, 19, 20	PCICLK [0:5]	OUT	PCI clock outputs.

5.3 Fixed Frequency Outputs

PIN	PIN NAME	TYPE	DESCRIPTION
1	REF0	OUT	14.318 MHz output.
	FS1*	IN _{tp120k}	Latched input for FS1 at initial power up for H/W selecting the output frequency clocks. This is internal 120KΩ pull up.
2	REF1	OUT	14.318 MHz output.
	FS0*	IN _{tp120k}	Latched input for FS0 at initial power up for H/W selecting the output frequency clocks. This is internal 120KΩ pull up.
3	REF2	OUT	14.318 MHz output.
21	24_48 MHz	OUT	48 MHz clock output.
	SEL24_48# ^{&}	IN _{td120k}	Latched input at initial power up for 24_48 MHz selecting the output frequency clocks. This is internal 120KΩ pull down, 1 = 24 MHz, 0 = 48 MHz (default).
22	48 MHz_USB	OUT	48 MHz clock output.
	FS3 ^{&}	IN _{td120k}	Latched input for FS3 at initial power up for H/W selecting the output frequency clocks. This is internal 120KΩ pull down.
23	48 MHz_DOT	OUT	48 MHz clock output.

5.4 I2C Control Interface

PIN	PIN NAME	TYPE	DESCRIPTION
33	SDATA*	I/OD	Serial data of I ² C 2-wire control interface with internal pull-up resistor.
32	SCLK*	IN	Serial clock of I ² C 2-wire control interface with internal pull-up resistor.

W83194BR-SD/W83194BG-SD



CLOCK GEN. FOR INTEL P4 SPRINGDALE/PRESCOTT SERIES CHIPSET

5.5 Output Control Pins

PIN	PIN NAME	TYPE	DESCRIPTION								
46	IREF	IN	Deciding the reference current for the CPUCLK pairs. The pin was connected to the precision resistor tied to ground to decide the appropriate current. The table is show as follows. <table border="1" data-bbox="625 562 1393 659"> <thead> <tr> <th>Board Target Trace</th> <th>Reference R, Iref</th> <th>Output Current</th> <th>Ioh @ Z</th> </tr> </thead> <tbody> <tr> <td>50 Ohms</td> <td>R = 475 Iref = 2.32mA</td> <td>Ioh = 6*Iref</td> <td>0.7V @ 50</td> </tr> </tbody> </table>	Board Target Trace	Reference R, Iref	Output Current	Ioh @ Z	50 Ohms	R = 475 Iref = 2.32mA	Ioh = 6*Iref	0.7V @ 50
Board Target Trace	Reference R, Iref	Output Current	Ioh @ Z								
50 Ohms	R = 475 Iref = 2.32mA	Ioh = 6*Iref	0.7V @ 50								
45	RESET#	OD	System reset signal when the watchdog is time out. This pin will generate 250 mS when the watchdog timer is timeout.								
34	VTT_PWRGD	IN	Power good input signal comes from ACPI with high active. This 3.3V input is level sensitive strobe used to determine FS [4:0] input are valid and is ready to sample. This pin is high active.								
	PD#*	IN	Power Down Function. This is internal 120KΩ pull up. This is multi-function pin. When the VTT_PWRGD signal is asserted (this is, turns from a logical Low to high), the pin will be switched into the function of power down (PD#).								

5.6 Power an GND Pins

PIN	PIN NAME	TYPE	DESCRIPTION
4	VDDREF	PWR	3.3V power supply for REF.
11, 17	VDDPCI	PWR	3.3V power supply for PCI.
25	VDD48	PWR	3.3V power supply for 48 MHz.
28	VDD3V66	PWR	3.3V power supply for 3V66.
35	VDD	PWR	3.3V power supply.
41	VDDCPU	PWR	3.3V power supply for CPU.
48	VDDA	PWR	3.3V power supply analog core.
7, 12, 18, 24, 29, 38, 44, 47	GND	PWR	Ground pin for 3.3 V

W83194BR-SD/W83194BG-SD



6. FREQUENCY SELECTION BY HARDWARE OR SOFTWARE

This frequency table is used at power on latched FS [4:0] value or software programming at SSEL [4:0] (Register 0 bit 7 ~ 3).

FS4	FS3	FS2	FS1	FS0	CPU (MHZ)	SRC (MHZ)	3V66(MHZ)	PCI (MHZ)
0	0	0	0	0	100.0	100/200	66.6	33.3
0	0	0	0	1	200.0	100/200	66.6	33.3
0	0	0	1	0	133.3	100/200	66.6	33.3
0	0	0	1	1	166.6	100/200	66.6	33.3
0	0	1	0	0	200.0	100/200	66.6	33.3
0	0	1	0	1	400.0	100/200	66.6	33.3
0	0	1	1	0	266.6	100/200	66.6	33.3
0	0	1	1	1	333.3	100/200	66.6	33.3
0	1	0	0	0	100.9	100/200	66.6	33.3
0	1	0	0	1	202	100/200	66.6	33.3
0	1	0	1	0	134.6	100/200	66.6	33.3
0	1	0	1	1	168.3	100/200	66.6	33.3
0	1	1	0	0	115	100/200	66.6	33.3
0	1	1	0	1	230	100/200	66.6	33.3
0	1	1	1	0	153.3	100/200	66.6	33.3
0	1	1	1	1	191.6	100/200	66.6	33.3
1	0	0	0	0	100	100/200	66.6	33.3
1	0	0	0	1	200	100/200	66.6	33.3
1	0	0	1	0	133.3	100/200	66.6	33.3
1	0	0	1	1	166.6	100/200	66.6	33.3
1	0	1	0	0	200	100/200	66.6	33.3
1	0	1	0	1	400	100/200	66.6	33.3
1	0	1	1	0	266.6	100/200	66.6	33.3
1	0	1	1	1	333.3	100/200	66.6	33.3
1	1	0	0	0	105	100/200	66.6	33.3
1	1	0	0	1	210	100/200	66.6	33.3
1	1	0	1	0	140	100/200	66.6	33.3
1	1	0	1	1	175	100/200	66.6	33.3
1	1	1	0	0	110	100/200	66.6	33.3
1	1	1	0	1	220	100/200	66.6	33.3
1	1	1	1	0	146.6	100/200	66.6	33.3
1	1	1	1	1	183.3	100/200	66.6	33.3

W83194BR-SD/W83194BG-SD



7. I²C CONTROL AND STATUS REGISTERS

(The register No. Is increased by 1 if use byte data read/write protocol)

7.1 Register 0: Frequency Select (Default =10H)

BIT	NAME	PWD	DESCRIPTION
7	SSEL [4]	0	Software frequency table selection through I ² C
6	SSEL [3]	0	
5	SSEL [2]	0	
4	SSEL [1]	1	
3	SSEL [0]	0	
2	EN_SSEL	0	Enable software table selection FS [4:0]. 0 = Hardware table setting (Jump mode). 1 = Software table setting through Bit7~3. (Jump less mode)
1	SPSPEN	0	Enable spread spectrum mode under clock output. 0 = Spread Spectrum mode disable 1 = Spread Spectrum mode enable
0	EN_SAFE_FREQ	0	After watchdog timeout 0 = Reload the hardware FS [4:0] latched pins setting. 1 = Reload the desirable frequency table selection defined at Reg-5 Bit 4~0.

7.2 Register 1: SRC/CPU Clock (1 = Enable, 0 = Disable) (Default = E3H)

BIT	NAME	PWD	DESCRIPTION
7	SRCCLKT SRCCLKC	1	Pin 37,36 SRCCLK T/C output control
6	CPUCLKT1 CPUCLKC1	1	Pin 43,42 CPUCLKT1/C1 output control
5	CPUCLKT0 CPUCLKC0	1	Pin 40,39 CPUCLKT0/C0 output control
4	FS4	X	Power on latched value of FS4 (9) pin, Default 0 (Read only)
3	FS3	X	Power on latched value of FS3 (22) pin. Default 0 (Read only)
2	FS2	X	Power on latched value of FS2 (8) pin. Default 0 (Read only)
1	FS1	X	Power on latched value of FS1 (1) pin. Default 1 (Read only)
0	FS0	X	Power on latched value of FS0 (2) pin. Default 1 (Read only)

W83194BR-SD/W83194BG-SD



7.3 Register 2: PCI Clock (1 = Enable, 0 = Disable) (Default = FFH)

BIT	NAME	PWD	DESCRIPTION
7	PCI_F2	1	Pin 10 PCI_F2 output control
6	PCI_F1	1	Pin 9 PCI_F1 output control
5	PCI_F0	1	Pin 8 PCI_F0 output control
4	Reserve	1	Reserved
3	PCI_5	1	Pin 20 PCI5 output control
2	PCI_4	1	Pin 19 PCI4 output control
1	Reserve	1	Reserved
0	PCI3	1	Pin 16 PCI3 output control

7.4 Register 3: PCI, 3V66 Clock (1 = Enable, 0 = Disable) (Default = EFH)

BIT	NAME	PWD	DESCRIPTION
7	PCI2	1	Pin 15 PCI2 output control
6	PCI1	1	Pin 14 PCI1 output control
5	PCI0	1	Pin 13 PCI0 output control
4	VCH_EN	X	Pin 26 3V66_3 / VCH output select 1: VCH output, 0: 3V66 output (Default) Default value follow hardware trapping data on VCH_EN ^{&} pin 26.
3	3V66_3	1	Pin 26 3V66_3 / VCH output control
2	3V66_2	1	Pin 27 3V66_2 output control
1	3V66_1	1	Pin 30 3V66_1 output control
0	3V66_0	1	Pin 31 3V66_0 output control

7.5 Register 4: 24_48 MHz, REF Control (1 = Enable, 0 = Disable) (Default =FCH)

BIT	NAME	PWD	DESCRIPTION
7	24_48 MHz	1	Pin 21 24_48 MHz output control
6	DOT48	1	Pin 23 DOT48 output control
5	USB48	1	Pin 22 USB48 output control
4	REF2	1	Pin 3 REF2 output control
3	REF1	1	Pin 2 REF1 output control
2	REF0	1	Pin 1 REF0 output control
1	MODE1	0	Clock output mode selection
0	MODE0	0	Refer to Table-1

W83194BR-SD/W83194BG-SD



Table-1: Clock output mode selection

MODE	NORMAL MODE	CPU OVER CLOCK MODE	CPU/SRC OVER CLOCK MODE
MODE1/0	00	01	10
CPU over clock	Byte 8 & 9	Byte 8 & 9	Byte 8 & 9
SRC over clock	Byte 8 & 9	Byte 4 & 10 (asynchronous)	Byte 8 & 9
AGP/PCI over clock	Byte 8 & 9	Byte 4 & 10 (asynchronous)	Byte 4 & 10 (asynchronous)
Spreading	All clocks are Effective	CPU is effective Only.	CPU and SRC are Effective.

7.6 Register 5: Watchdog Control (Default = 00H)

BIT	NAME	PWD	DESCRIPTION
7	SEL24	X	Pin 21 24 / 48 MHz output selection 1: 24 MHz, 0: 48 MHz. (Default) Default value follow hardware trapping data on SEL24_48# pin.
6	EN_WD	0	Program this bit => 1: Enable Watchdog Timer feature. 0: Disable Watchdog Timer feature. Read-back this bit => During timer count down the bit read back to 1. If count to zero, this bit read back to 0
5	WD_TIMEOUT	0	Read Back only. Timeout Flag. 1: Watchdog has ever started and counts to zero. 0: Watchdog is restarted and counting.
4	SAF_FREQ [4]	0	These bits will be reloaded in Reg-0 to select frequency table. As the watchdog is timeout and EN_SAFE_FREQ = 1.
3	SAF_FREQ [3]	0	
2	SAF_FREQ [2]	0	
1	SAF_FREQ [1]	0	
0	SAF_FREQ [0]	0	

W83194BR-SD/W83194BG-SD



7.7 Register 6: Watchdog Timer (Default =08H)

BIT	NAME	PWD	DESCRIPTION
7	WD_TIME [7]	0	Setting the down count depth. One bit resolution represents 250 mS. Default time depth is 8*250 mS = 2.0 second. If the watchdog timer is counting, this register will return present down count value.
6	WD_TIME [6]	0	
5	WD_TIME [5]	0	
4	WD_TIME [4]	0	
3	WD_TIME [3]	1	
2	WD_TIME [2]	0	
1	WD_TIME [1]	0	
0	WD_TIME [0]	0	

7.8 Register 7: Asynchronous Program (Default = 40H)

BIT	NAME	PWD	DESCRIPTION
7	Tri-state	0	Tri-state all output if set 1
6	Reserve	1	Reserved
5	Reserve	0	Reserved
4	Reserve	0	Reserved
3	Reserve	0	Reserved
2	Reserve	0	Reserved
1	ASEL<1>	0	Asynchronous AGP/PCI frequency table selection
0	ASEL<0>	0	ASEL<1:0> 00: 66.6 MHz 01:72.1 MHz 10: 79.9 MHz 11:68.7 MHz

7.9 Register 8: M/N Program (Default = 8AH)

BIT	NAME	PWD	DESCRIPTION
7	N_DIV [8]	1	Programmable N divisor value. Bit 7 ~0 are defined in the Register 8.
6	M_DIV [6]	0	Programmable M divisor value.
5	M_DIV [5]	0	
4	M_DIV [4]	0	
3	M_DIV [3]	1	
2	M_DIV [2]	0	
1	M_DIV [1]	1	
0	M_DIV [0]	0	

W83194BR-SD/W83194BG-SD



7.10 Register 9: M/N Program (Default = CEH)

BIT	NAME	PWD	DESCRIPTION
7	N_DIV [7]	1	Programmable N divisor value bit 7 ~ 0. The bit 8 is defined in Register 7.
6	N_DIV [6]	1	
5	N_DIV [5]	0	
4	N_DIV [4]	0	
3	N_DIV [3]	1	
2	N_DIV [2]	1	
1	N_DIV [1]	1	
0	N_DIV [0]	0	

7.11 Register 10: M/N Program (Default = 13H)

BIT	NAME	PWD	DESCRIPTION
7	Reserve	0	Reserved
6	N3<6>	0	Programmable N3 divisor bit 6 ~ 0 for synchronism SRC/AGP/PCI clock.
5	N3<5>	0	
4	N3<4>	1	
3	N3<3>	0	
2	N3<2>	0	
1	N3<1>	1	
0	N3<0>	1	

7.12 Register 11: Spread Spectrum Programming (Default = 2FH)

BIT	NAME	PWD	DESCRIPTION
7	SP_UP [3]	0	Spread Spectrum Up Counter bit 3 ~ bit 0.
6	SP_UP [2]	0	
5	SP_UP [1]	1	
4	SP_UP [0]	0	
3	SP_DOWN [3]	1	Spread Spectrum Down Counter bit 3 ~ bit 0 2's complement representation. Ex: 1 -> 1111; 2 -> 1110; 7 -> 1001; 8 -> 1000
2	SP_DOWN [2]	1	
1	SP_DOWN [1]	1	
0	SP_DOWN [0]	1	

W83194BR-SD/W83194BG-SD



7.13 Register 12: Divider Ratio (Default = C6H)

BIT	NAME	PWD	DESCRIPTION
7	SRC_H	1	SRC frequency select, 1: 100 MHz, 0: 200 MHz
6	DS9	1	Define the AGP divider ratio, Table-2 integrate the all divider configuration
5	DS5	0	Define the AGP divider ratio
4	DS4	0	Table-2 integrate the all divider configuration
3	DS3	0	Define the SRC divider ratio
2	DS2	1	Refer to Table-2
1	DS1	1	Define the SRC divider ratio
0	DS0	0	Refer to Table-2

Table-2 CPU, SRC, AGP, PCI divider ratio selection Table

MSB \ LSB		CPU		SRC		AGP			
		Bit0		Bit2		Bit5, 4			
		0	1	0	1	00	01	10	11
Bit1/ Bit3/Bit6	0	Div2	Div3	Div2	Div3	Div5	Div6	Div7	Div8
	1	Div4	Div5	Div4	Div5	Div10	Div12	Div12	Div12

7.14 Register 13: Control (Default = 0FH)

BIT	NAME	PWD	DESCRIPTION
7	EN_MN_PROG	0	0: Output frequency depend on frequency table 1: Program all clock frequency by changing M/N value The equation is $VCO = 14.318MHz * (N+4) / M$. Once the watchdog timer timeout, the bit will be clear. Then the frequency will be decided by hardware default FS<4:0> or desired frequency select SAF_FREQ [4:0] depend on EN_SAFE_FREQ (Reg9 - bit 7).
6	Reserve	0	Reserved
5	Reserve	0	Reserved
4	Reserve	0	
3	IVAL<3>	1	Charge pump current selection
2	IVAL<2>	1	
1	IVAL<1>	1	
0	IVAL<0>	1	

W83194BR-SD/W83194BG-SD



CLOCK GEN. FOR INTEL P4 SPRINGDALE/PRESCOTT SERIES CHIPSET

7.15 Register 14: Control (Default = 27H)

BIT	NAME	PWD	DESCRIPTION
7	CPUT_DRI	0	CPUT output state in during POWER DOWN or Stop mode assertion. 1: Driven (2*Iref), 0: Tristate (Floating) CPUC always tri-state (floating) in power down Assertion.
6	SRCT_DRI	0	SRC_T output state in during POWER DOWN or Stop mode assertion. 1: Driven (6*Iref), 0: Tristate (Floating) SRC_C always tri-state (floating) in power down Assertion.
5	SPCNT [5]	1	Spread Spectrum Programmable time, the resolution is 280ns. Default period is 11.8us
4	SPCNT [4]	0	
3	SPCNT [3]	0	
2	SPCNT [2]	1	
1	SPCNT [1]	1	
0	SPCNT [0]	1	

7.16 Register 15: Control (Default =3CH)

BIT	NAME	PWD	DESCRIPTION
7	INV_CPU	0	Invert the CPU phase 0: Default, 1: Inverse
6	Reserve	0	Reserved
5	Reserve	1	Reserved
4	SPSP1	1	Spread Spectrum type select.
3	SPSP0	1	00: Down 1% 01: Down 0.5% 10: Center ±0.5% 11: Center ±0.25%
2	ASKEW [2]	1	CPU to AGP skew control.
1	ASKEW [1]	0	
0	ASKEW [0]	0	

7.17 Register 16: Control (Default = 24H)

BIT	NAME	PWD	DESCRIPTION
7	INV_AGP	0	Invert the AGP phase 0: Default, 1: Inverse
6	INV_PCI	0	Invert the PCI phase 0: Default, 1: Inverse

W83194BR-SD/W83194BG-SD



CLOCK GEN. FOR INTEL P4 SPRINGDALE/PRESCOTT SERIES CHIPSET

Register 16: Control (Default = 24H), continued

BIT	NAME	PWD	DESCRIPTION
5	SSKEW [2]	1	CPU to SRC skew control
4	SSKEW [1]	0	
3	SSKEW [0]	0	
2	PSKEW [2]	1	CPU to PCI skew control
1	PSKEW [1]	0	
0	PSKEW [0]	0	

7.18 Register 17: Slew Rate Control (Default = 00H)

BIT	NAME	PWD	DESCRIPTION
7	PCI_F2_S2	0	PCI_F2 slew rate control
6	PCI_F2_S1	0	11: Strong, 00: Weak, 10/01: Normal
5	PCI_F0_S2	0	PCI_F1 / PCI_F0 slew rate control
4	PCI_F0_S1	0	11: Strong, 00: Weak, 10/01: Normal
3	AGP_32_S2	0	3V66_3 / 3V66_2 slew rate control
2	AGP_32_S1	0	11: Strong, 00: Weak, 10/01: Normal
1	AGP_10_S2	0	3V66_1 / 3V66_0 slew rate control
0	AGP_10_S1	0	11: Strong, 00: Weak, 10/01: Normal

7.19 Register 18: Slew Rate Control (Default = 00H)

BIT	NAME	PWD	DESCRIPTION
7	PCI_75_S2	0	PCI7, 6, 5 slew rate control
6	PCI_75_S1	0	11: Strong, 00: Weak, 10/01: Normal
5	PCI_42_S2	0	PCI4, 3, 2 slew rate control
4	PCI_42_S1	0	11: Strong, 00: Weak, 10/01: Normal
3	PCI_10_S2	0	PCI1, 0 slew rate control
2	PCI_10_S1	0	11: Strong, 00: Weak, 10/01: Normal
1	REF_S2	0	REF slew rate control
0	REF_S1	0	11: Strong, 00: Weak, 10/01: Normal

W83194BR-SD/W83194BG-SD



7.20 Register 19: Control (Default = 0AH)

BIT	NAME	PWD	DESCRIPTION
7	CPUSTOP_EN	0	Stop all CPU clocks. 1: Enable stop feature, 0: Disable
6	PCISTOP_EN	0	Stop SRC clock and all PCI clocks except free running parts. 1: Enable stop feature, 0: Disable
5	SRCS_EN	0	Allow PCISTOP pin to affect SRC output state 1: Allow, 0: Ignore the PCISTOP pin effect (Free running)
4	INV_DOT48	0	Invert the DOT48 phase 0: In phase with USB48, 1: 180 degrees out of phase
3	INV_USB48	1	Invert the USB48 phase 0: In phase with DOT48, 1: 180 degrees out of phase
2	USB48_S2	0	USB48/DOT48/USB24_48 slew rate control
1	USB48_S1	1	
0	INV_SRC	0	Invert the SRC phase, 0: Default, 1: Inverse

7.21 Register 20: Winbond Chip ID – Project Code (Ready Only) (Default = 47H)

BIT	NAME	PWD	DESCRIPTION
7	CHPI_ID [7]	0	Winbond Chip ID. W83194BR-SD (SA5847).
6	CHPI_ID [6]	1	Winbond Chip ID.
5	CHPI_ID [5]	0	Winbond Chip ID.
4	CHPI_ID [4]	0	Winbond Chip ID.
3	CHPI_ID [3]	0	Winbond Chip ID.
2	CHPI_ID [2]	1	Winbond Chip ID.
1	CHPI_ID [1]	1	Winbond Chip ID.
0	CHPI_ID [0]	1	Winbond Chip ID.

W83194BR-SD/W83194BG-SD



7.22 Register 21: Reserved (Ready Only) (Default = 50H)

BIT	NAME	PWD	DESCRIPTION
7	Reserved	0	Reserved
6	Reserved	1	
5	Reserved	0	Reserved
4	Reserved	1	
3	Reserved	0	Reserved
2	Reserved	0	
1	Reserved	0	Reserved
0	Reserved	0	

W83194BR-SD/W83194BG-SD



8. ACCESS INTERFACE

The W83194BR-SD provides I²C Serial Bus for microprocessor to read/write internal registers. In the W83194BR-SD is provided Block Read/Block Write and Byte-Data Read/Write protocol. The I²C address is defined at 0xD2.

Block Read and Block Write Protocol

8.1 Block Write Protocol

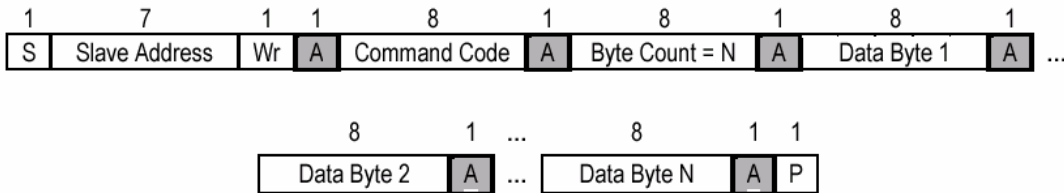

8.2 Block Read Protocol

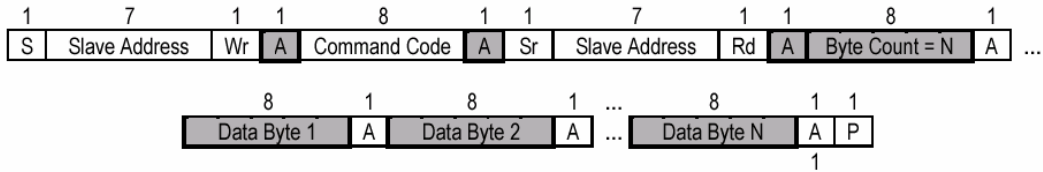

In block mode, the command code must filled 00H

8.3 Byte Write Protocol

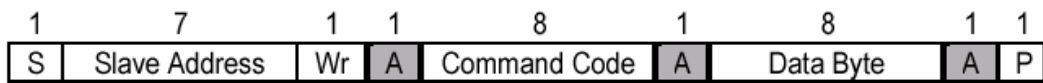

8.4 Byte Read Protocol

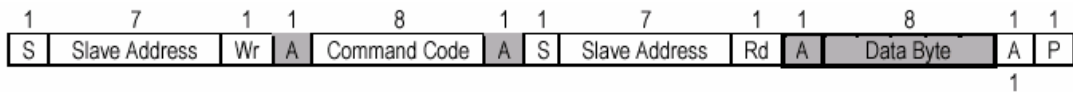

W83194BR-SD/W83194BG-SD



9. SPECIFICATIONS

9.1 Absolute Maximum Ratings

Stresses greater than those listed in this table may cause permanent damage to the device. Precautions should be taken to avoid application of any voltage higher than the maximum rated voltages to this circuit. Subjection to maximum conditions for extended periods may affect reliability. Unused inputs must always be tied to an appropriate logic voltage level (Ground or VDD).

PARAMETER	RATING
Absolute 3.3V Core Supply Voltage	-0.5V to +4.6V
Absolute 3.3V I/O Supply Voltage	-0.5 V to +4.6 V
Operating 3.3V Core Supply Voltage	3.135V to 3.465V
Operating 3.3V I/O Supply Voltage	3.135V to 3.465V
Storage Temperature	-65°C to +150°C
Ambient Temperature	-55°C to +125°C
Operating Temperature	0°C to +70°C
Input ESD Protection (Human body model)	2000V

9.2 General Operating Characteristics

VDDREF = VDDA = VDDCPU = VDD3V66 = VDDPCI = VDD48 = 3.3V ±5 %, TA = 0°C to +70°C, CI = 10pF

PARAMETER	SYM.	MIN.	MAX.	UNITS	TEST CONDITIONS
Input Low Voltage	V _{IL}		0.8	V _{DC}	
Input High Voltage	V _{IH}	2.0		V _{DC}	
Output Low Voltage	V _{OL}		0.4	V _{DC}	All outputs using 3.3V power
Output High Voltage	V _{OH}	2.4		V _{DC}	All outputs using 3.3V power
Operating Supply Current	I _{dd}		350	mA	CPU = 100 to 400 MHz PCI = 33.3 MHz with load
Input Pin Capacitance	C _{in}		5	pF	
Output Pin Capacitance	C _{out}		6	pF	
Input Pin Inductance	L _{in}		7	nH	

9.3 Skew Group Timing Clock

VDDREF = VDDA = VDDCPU = VDD3V66 = VDDPCI = VDD48 = 3.3V ±5 %, TA = 0°C to +70°C, CI = 10 pF

PARAMETER	MIN.	TYP.	MAX.	UNITS	TEST CONDITIONS
3V66 to PCI Skew	1.5	2.6	3.5	nS	Measured at 1.5V
CPU to CPU Skew			100	pS	Crossing point
3V66 to 3V66 Skew			250	pS	Measured at 1.5V
PCI to PCI Skew			500	pS	Measured at 1.5V
48 MHz to 48 MHz Skew			1000	pS	Measured at 1.5V
REF to REF Skew			500	pS	Measured at 1.5V

W83194BR-SD/W83194BG-SD



9.4 CPU 0.7V Electrical Characteristics

VDDA = VDDCPU = 3.3V \pm 5 %, TA = 0°C to +70°C, Test load Rs = 33, Rp = 49.9 CI = 10pF, Vol = 0.14V, Voh = 0.56V, Vr = 475, IREF = 2.32 mA, Ioh = 6*IREF

PARAMETER	MIN.	MAX.	UNITS	TEST CONDITIONS
Rise Time	175	700	pS	100 to 200 MHz
Fall Time	175	700	pS	100 to 200 MHz
Absolute Crossing Point Voltages	250	550	mV	100 to 200 MHz
Cycle to Cycle Jitter		125	pS	100 to 200 MHz
Duty Cycle	45	55	%	100 to 200 MHz

9.5 SRC 0.7V Electrical Characteristics

VDD = 3.3V \pm 5 %, TA = 0°C to +70°C, Test load Rs = 33, Rp = 49.9 CI = 10pF, Vol = 0.14V, Voh = 0.56V, Vr = 475, IREF = 2.32 mA, Ioh = 6*IREF

PARAMETER	MIN.	MAX.	UNITS	TEST CONDITIONS
Rise Time	175	700	pS	100 to 200 MHz
Fall Time	175	700	pS	100 to 200 MHz
Absolute crossing point Voltages	250	550	mV	100 to 200 MHz
Cycle to Cycle jitter		125	pS	100 to 200 MHz
Duty Cycle	45	55	%	100 to 200 MHz

9.6 3V66 Electrical Characteristics

VDD3V66 = 3.3V \pm 5 %, TA = 0°C to +70°C, Test load, CI = 10pF

PARAMETER	MIN.	MAX.	UNITS	TEST CONDITIONS
Rise Time	500	2000	pS	Measure from 0.4V to 2.4V
Fall Time	500	2000	pS	Measure from 2.4V to 0.4V
Cycle to Cycle Jitter		250	pS	Measure 1.5V point
Duty Cycle	45	55	%	
Pull-Up Current Min.	-33		mA	Vout = 1.0V
Pull-Up Current Max.		-33	mA	Vout = 3.135V
Pull-Down Current Min.	30		mA	Vout = 1.95V
Pull-Down Current Max.		38	mA	Vout = 0.4V

W83194BR-SD/W83194BG-SD



9.7 PCI Electrical Characteristics

VDDPCI= 3.3V ±5 %, TA = 0°C to +70°C, Test load, CI = 10pF,

PARAMETER	MIN.	MAX.	UNITS	TEST CONDITIONS
Rise Time	500	2000	pS	Measure from 0.4V to 2.4V
Fall Time	500	2000	pS	Measure from 2.4V to 0.4V
Cycle to Cycle Jitter		250	pS	Measure 1.5V point
Duty Cycle	45	55	%	
Pull-Up Current Min.	-33		mA	Vout = 1.0V
Pull-Up Current Max.		-33	mA	Vout = 3.135V
Pull-Down Current Min.	30		mA	Vout = 1.95V
Pull-Down Current Max.		38	mA	Vout = 0.4V

9.8 24M, 48M Electrical Characteristics

VDD48 = 3.3V ±5 %, TA = 0°C to +70°C, Test load, CI = 10pF,

PARAMETER	MIN.	MAX.	UNITS	TEST CONDITIONS
Rise Time	500	2000	pS	Measure from 0.4V to 2.4V
Fall Time	500	2000	pS	Measure from 2.4V to 0.4V
Long Term Jitter		500	pS	Measure 1.5V point
Duty Cycle	45	55	%	
Pull-Up Current Min.	-33		mA	Vout = 1.0V
Pull-Up Current Max.		-33	mA	Vout = 3.135V
Pull-Down Current Min.	30		mA	Vout = 1.95V
Pull-Down Current Max.		38	mA	Vout = 0.4V

9.9 REF Electrical Characteristics

VDDREF= 3.3V ±5 %, TA = 0°C to +70°C, Test load, CI = 10 pF

PARAMETER	MIN.	MAX.	UNITS	TEST CONDITIONS
Rise Time	1000	4000	pS	Measure from 0.4V to 2.4V
Fall Time	1000	4000	pS	Measure from 2.4V to 0.4V
Cycle to Cycle Jitter		1000	pS	Measure 1.5V point
Duty Cycle	45	55	%	
Pull-Up Current Min.	-33		mA	Vout = 1.0V
Pull-Up Current Max.		-33	mA	Vout = 3.135V
Pull-Down Current Min.	30		mA	Vout = 1.95V
Pull-Down Current Max.		38	mA	Vout = 0.4V

W83194BR-SD/W83194BG-SD



10. ORDERING INFORMATION

PART NUMBER	PACKAGE TYPE	PRODUCTION FLOW
W83194BR-SD	48 PIN SSOP	Commercial, 0°C to +70°C
W83194BG-SD	48 PIN SSOP (Pb-free package)	Commercial, 0°C to +70°C

11. HOW TO READ THE TOP MARKING

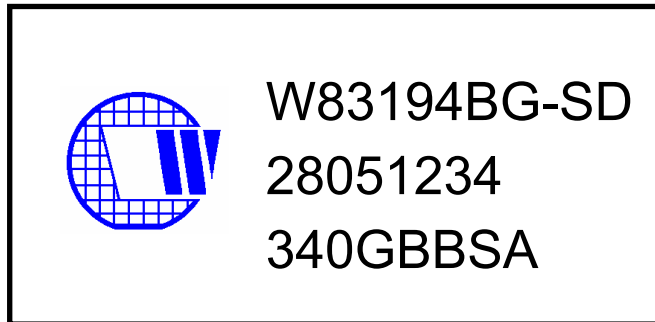
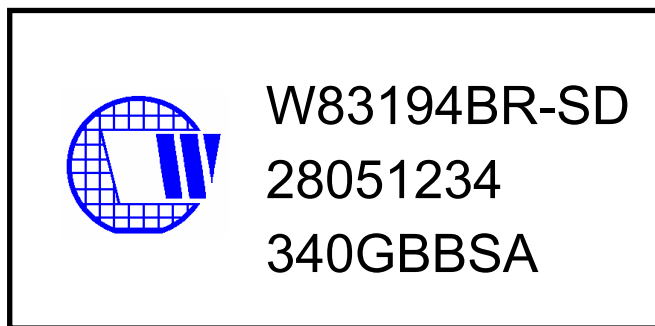

1st line: Winbond logo and the type number: W83194BR-SD, W83194BG-SD

2nd line: Tracking code 2 8051234

2: wafers manufactured in Winbond FAB 2

8051234: wafer production series lot number

3rd line: Tracking code 340 G B B SA

340: packages made in '2003, week 40

G: assembly house ID; L means Lingsen, O means OSE, G means GR

B: Internal use code

B: IC revision

SA: mask version

All the trade marks of products and companies mentioned in this data sheet belong to their respective owners.

W83194BR-SD/W83194BG-SD



12. PACKAGE DRAWING AND DIMENSIONS

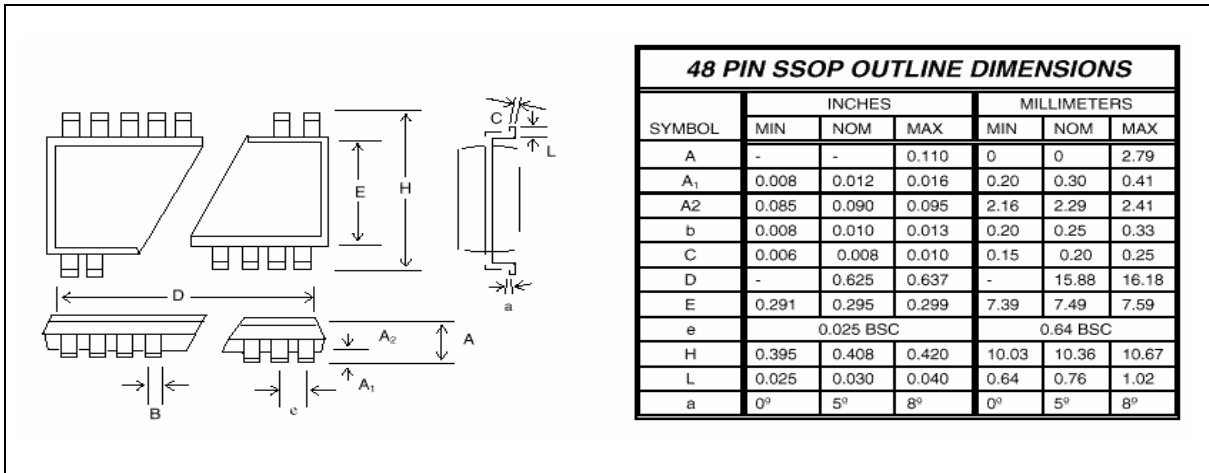

Please note that all data and specifications are subject to change without notice. All the trade marks of products and companies mentioned in this data sheet belong to their respective owners.

Important Notice

Winbond products are not designed, intended, authorized or warranted for use as components in systems or equipment intended for surgical implantation, atomic energy control instruments, airplane or spaceship instruments, transportation instruments, traffic signal instruments, combustion control instruments, or for other applications intended to support or sustain life. Further more, Winbond products are not intended for applications wherein failure of Winbond products could result or lead to a situation wherein personal injury, death or severe property or environmental damage could occur.

Winbond customers using or selling these products for use in such applications do so at their own risk and agree to fully indemnify Winbond for any damages resulting from such improper use or sales.