

International IR Rectifier

20CTQ... 20CTQ...S 20CTQ... -1

SCHOTTKY RECTIFIER

20 Amp

$I_{F(AV)} = 20\text{Amp}$
 $V_R = 35 \text{ to } 45\text{V}$

Major Ratings and Characteristics

Characteristics	20CTQ	Units
$I_{F(AV)}$ Rectangular waveform	20	A
V_{RRM} range	35 to 45	V
I_{FSM} @ $t_p = 5 \mu\text{s}$ sine	1060	A
V_F @ 10Apk , $T_J = 125^\circ\text{C}$ (per leg)	0.57	V
T_J range	-55 to 175	$^\circ\text{C}$

Description/Features

The 20CTQ center tap Schottky rectifier series has been optimized for low reverse leakage at high temperature. The proprietary barrier technology allows for reliable operation up to 175°C junction temperature. Typical applications are in switching power supplies, converters, free-wheeling diodes, and reverse battery protection.

- 175°C T_J operation
- Center tap TO-220 package
- Low forward voltage drop
- High purity, high temperature epoxy encapsulation for enhanced mechanical strength and moisture resistance
- High frequency operation
- Guard ring for enhanced ruggedness and long term reliability

Case Styles

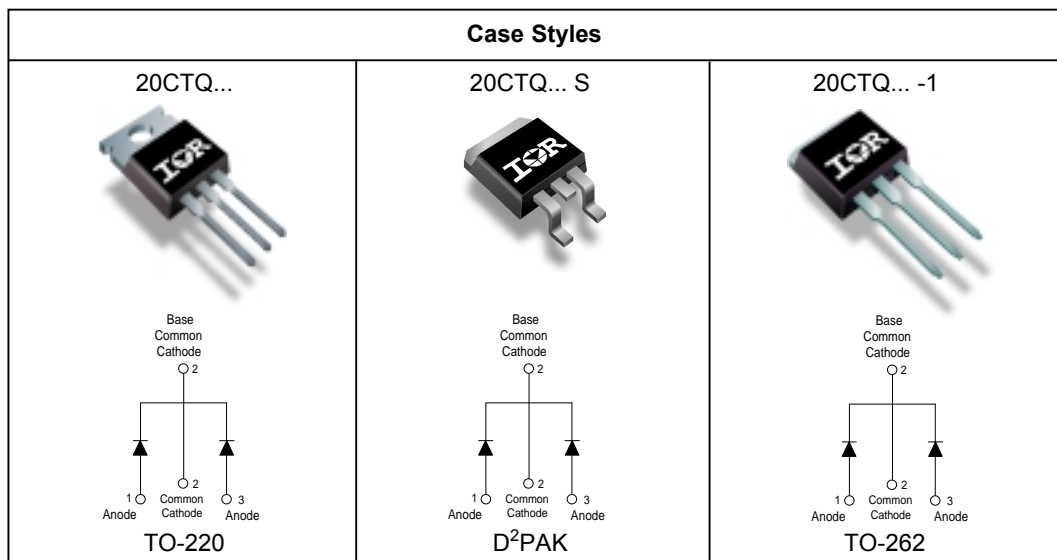

Voltage Ratings

Part number	20CTQ035	20CTQ040	20CTQ045
V_R Max. DC Reverse Voltage (V)	35	40	45
V_{RWM} Max. Working Peak Reverse Voltage (V)			

Absolute Maximum Ratings

Parameters	20CTQ	Units	Conditions
$I_{F(AV)}$ Max. Average Forward Current * See Fig. 5	20	A	50% duty cycle @ $T_C = 145^\circ\text{C}$, rectangular wave form
I_{FSM} Max. Peak One Cycle Non-Repetitive Surge Current (Per Leg) * See Fig. 7	1060	A	Following any rated load condition and with rated V_{RRM} applied
	265		
E_{AS} Non-Repetitive Avalanche Energy (Per Leg)	13	mJ	$T_J = 25^\circ\text{C}$, $I_{AS} = 2.0$ Amps, $L = 6.5$ mH
I_{AR} Repetitive Avalanche Current (Per Leg)	2.0	A	Current decaying linearly to zero in 1 μsec Frequency limited by T_J max. $V_A = 1.5 \times V_R$ typical

Electrical Specifications

Parameters	20CTQ	Units	Conditions
V_{FM} Max. Forward Voltage Drop (Per Leg) * See Fig. 1 (1)	0.64	V	@ 10A $T_J = 25^\circ\text{C}$
	0.76	V	@ 20A
	0.57	V	@ 10A $T_J = 125^\circ\text{C}$
	0.68	V	@ 20A
I_{RM} Max. Reverse Leakage Current (Per Leg) * See Fig. 2 (1)	2	mA	$T_J = 25^\circ\text{C}$ $V_R = \text{rated } V_R$
	15	mA	$T_J = 125^\circ\text{C}$
C_T Max. Junction Capacitance (Per Leg)	900	pF	$V_R = 5V_{DC}$, (test signal range 100Khz to 1Mhz) 25°C
L_S Typical Series Inductance (Per Leg)	8.0	nH	Measured lead to lead 5mm from package body
dv/dt Max. Voltage Rate of Change (Rated V_R)	10000	V/ μs	

(1) Pulse Width < 300 μs , Duty Cycle <2%

Thermal-Mechanical Specifications

Parameters	20CTQ	Units	Conditions
T_J Max. Junction Temperature Range	-55 to 175	$^\circ\text{C}$	
T_{stg} Max. Storage Temperature Range	-55 to 175	$^\circ\text{C}$	
R_{thJC} Max. Thermal Resistance Junction to Case (Per Leg)	3.25	$^\circ\text{C}/\text{W}$	DC operation * See Fig. 4
R_{thJC} Max. Thermal Resistance Junction to Case (Per Package)	1.63	$^\circ\text{C}/\text{W}$	DC operation
R_{thCS} Typical Thermal Resistance, Case to Heatsink	0.50	$^\circ\text{C}/\text{W}$	Mounting surface, smooth and greased
wt Approximate Weight	2 (0.07)	g (oz.)	
T Mounting Torque	Min. 6 (5)	Kg-cm (lbf-in)	
	Max. 12 (10)		

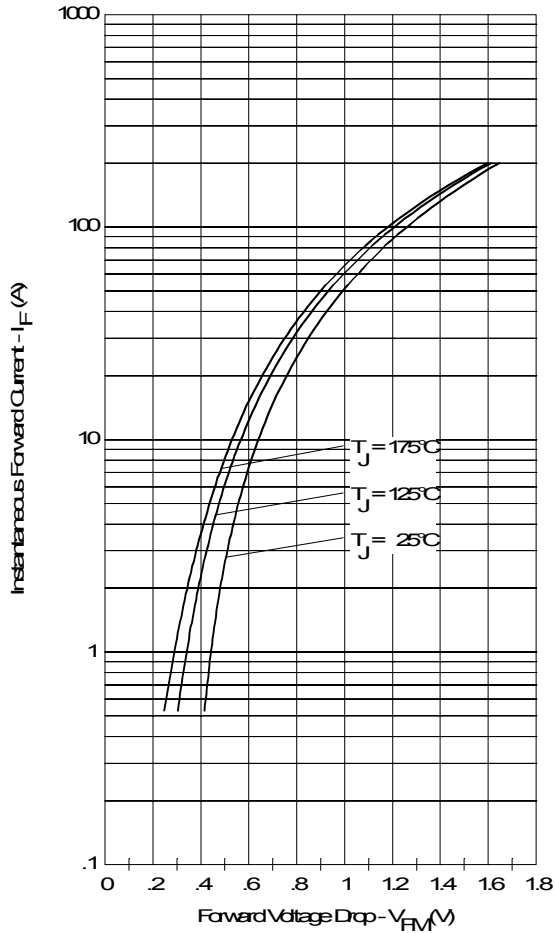

Fig. 1 - Max. Forward Voltage Drop Characteristics (Per Leg)

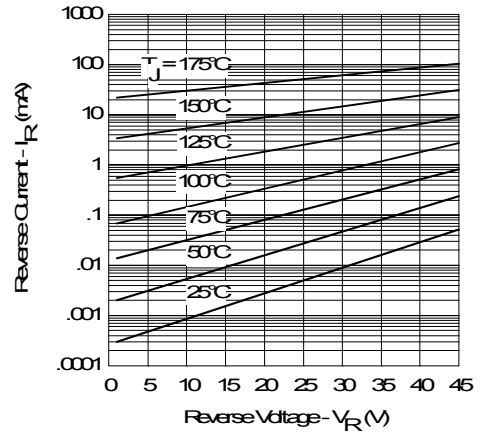

Fig. 2 - Typical Values Of Reverse Current Vs. Reverse Voltage (Per Leg)

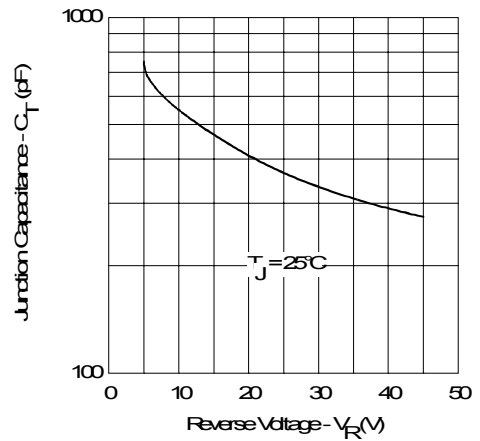

Fig. 3 - Typical Junction Capacitance Vs. Reverse Voltage (Per Leg)

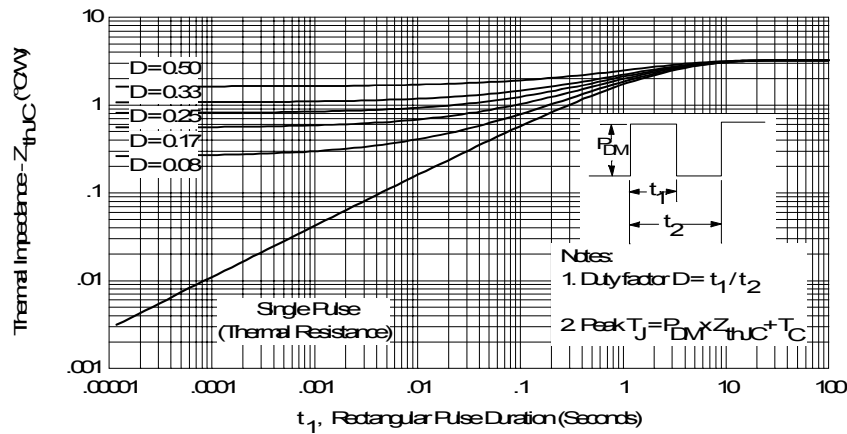

Fig. 4 - Max. Thermal Impedance Z_{thJC} Characteristics (Per Leg)

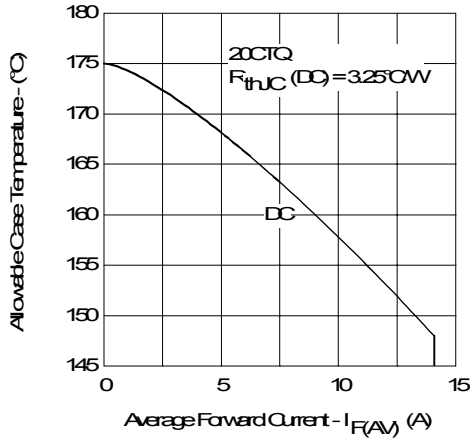

Fig. 5 - Max. Allowable Case Temperature Vs. Average Forward Current (Per Leg)

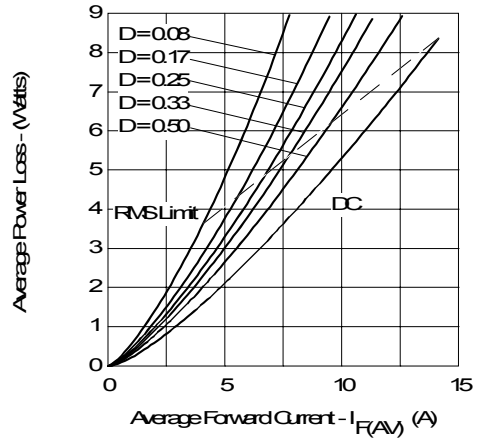

Fig. 6 - Forward Power Loss Characteristics (Per Leg)

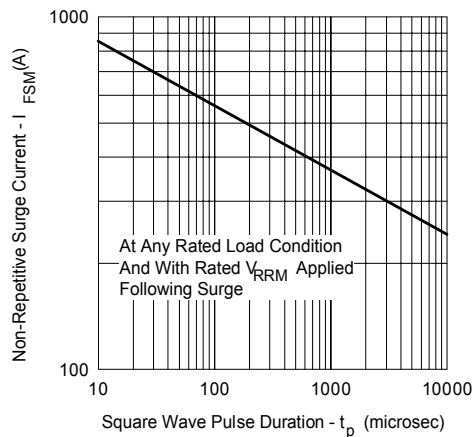

Fig. 7 - Max. Non-Repetitive Surge Current (Per Leg)

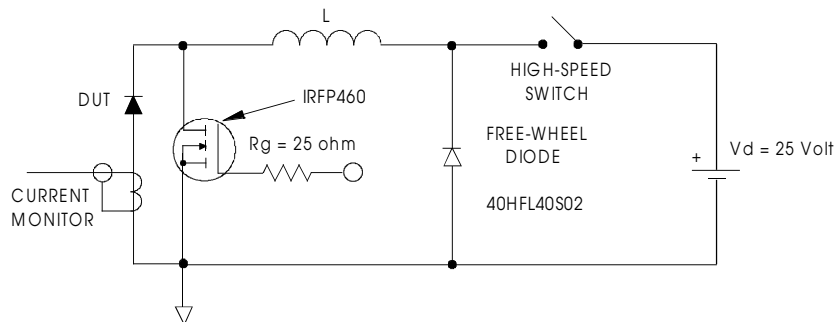
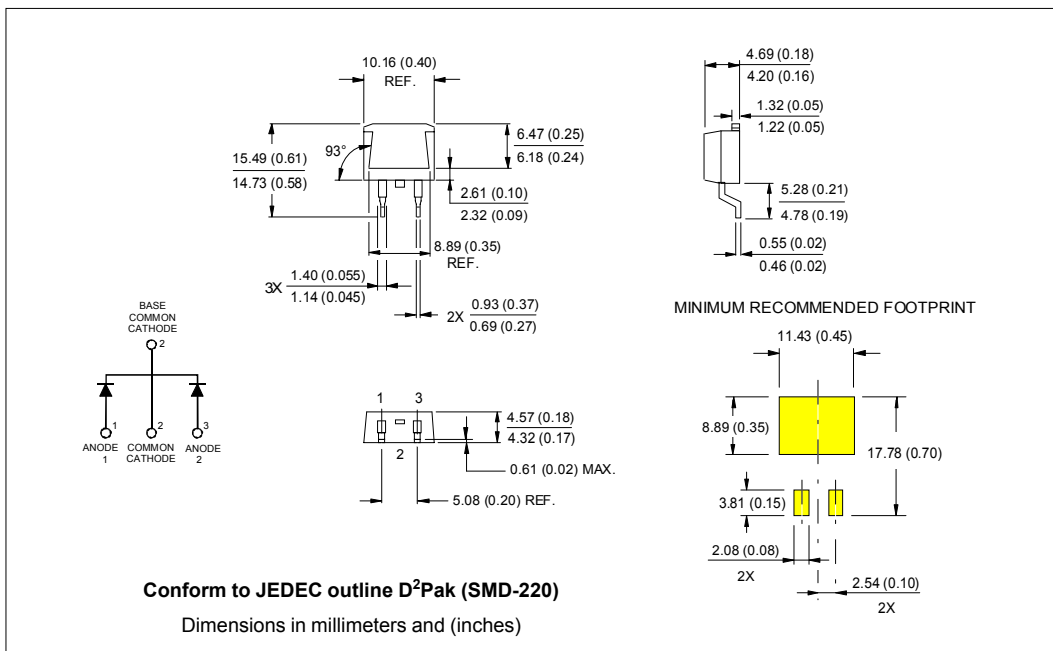
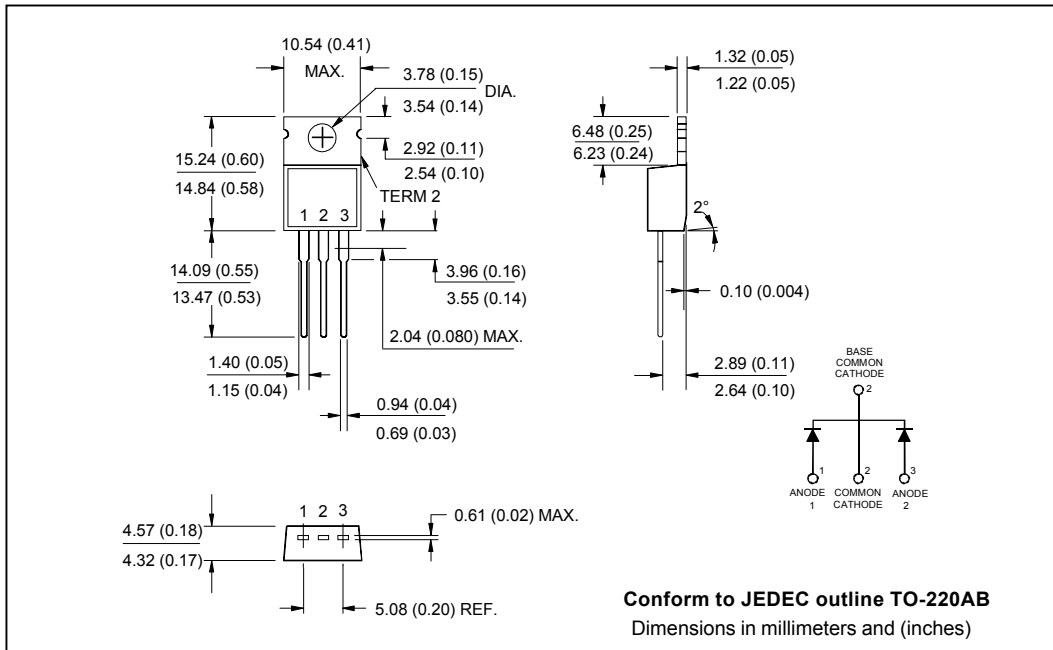
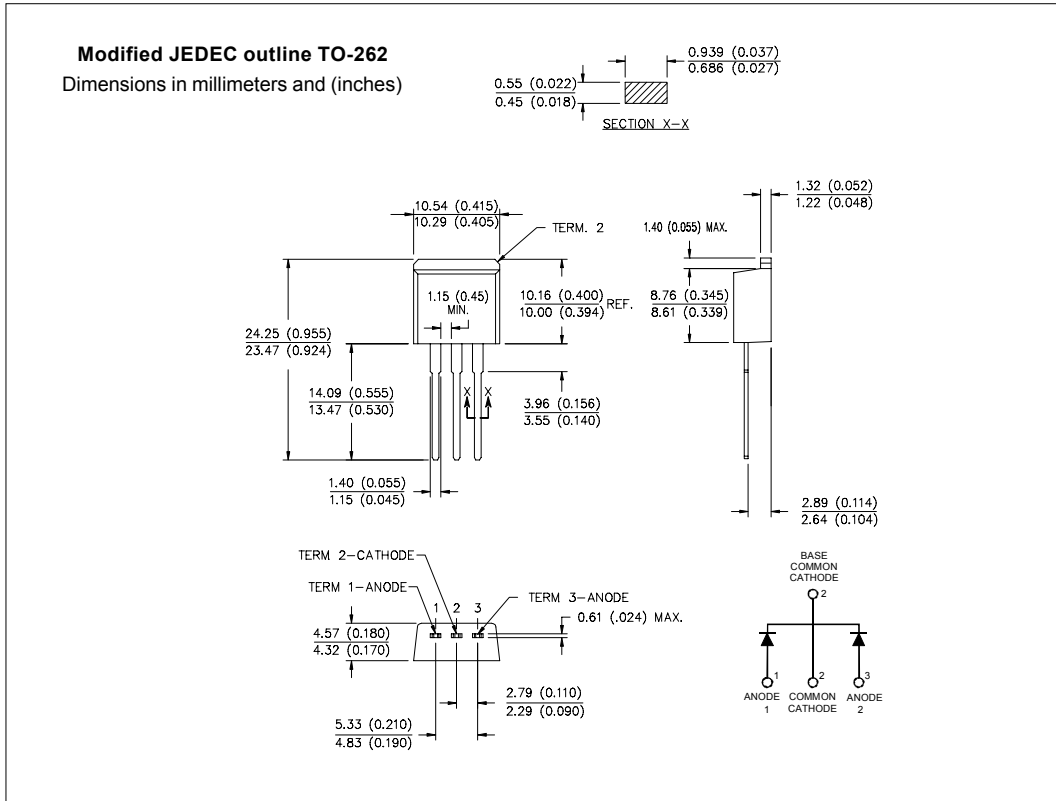

Fig. 8 - Unclamped Inductive Test Circuit

Outline Table



Outline Table



Marking Information

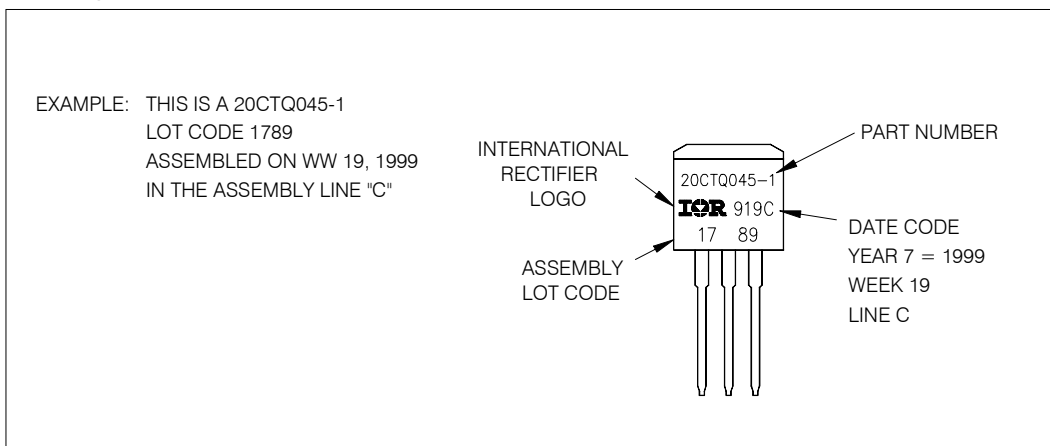

Tape & Reel Information

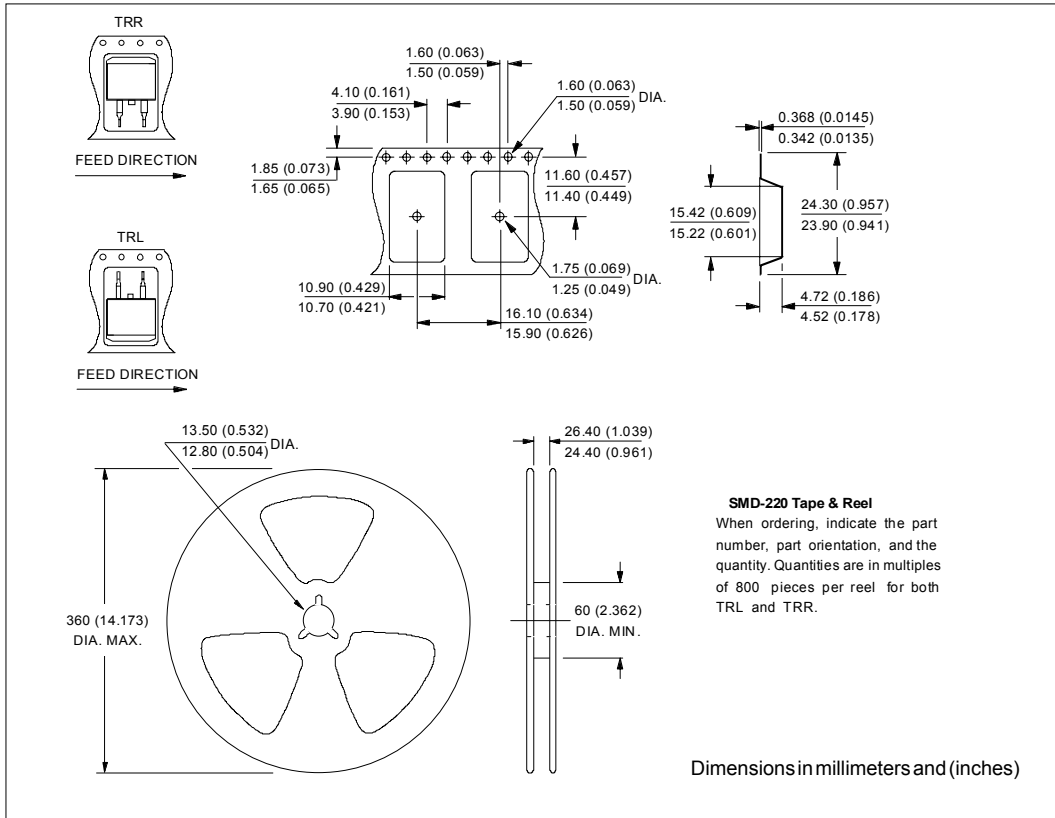

Ordering Information Table

Device Code

20	C	T	Q	045	-1
①	②	③	④	⑤	⑥

- 1** - Essential Part Number
- 2** - Common Cathode
- 3** - T = TO-220
- 4** - Q = Schottky Q Series
- 5** - Voltage Rating
- 6** - S = D²Pak
- 1 = TO-262

035 = 35V
040 = 40V
045 = 45V

20CTQ... Series

Bulletin PD-20056 rev. A 12/01

International
IOR Rectifier

Data and specifications subject to change without notice.
This product has been designed and qualified for Industrial Level.
Qualification Standards can be found on IR's Web site.

International
IOR Rectifier

IR WORLD HEADQUARTERS: 233 Kansas St., El Segundo, California 90245, USA Tel: (310) 252-7105

TAC Fax: (310) 252-7309

Visit us at www.irf.com for sales contact information. 12/01

This datasheet has been download from:

www.datasheetcatalog.com

Datasheets for electronics components.