

ZT Miniature Relays

2/4 pole, 5 A

ZT2*** 2 changeover contacts, IP 40

ZT5*** 4 changeover contacts, IP 40,
with additional insulating ribs

For dc or ac operation, neutral, monostable

PC-3 mounting or plug-in, AMP 2,8 (solder terminals)

Mechanical and electrical operating
state indicator (option)

With test button; new test button system:

- protected against accidental contact
- can be locked by means of a lever
integrated into the cap
- test button can be operated from the front

White label for markings

Contact material cadmium free

VDE, SEV, UL, CSA

Approximate weight: 31 g

Base terminals

ZT2 2 changeover contacts, 2 pole

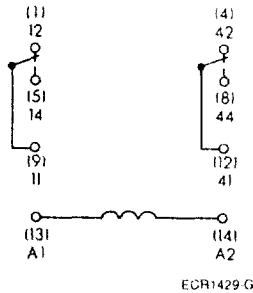

ZT5 4 changeover contacts, 4 pole

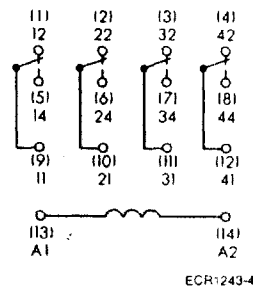

Solder pins or plug pins

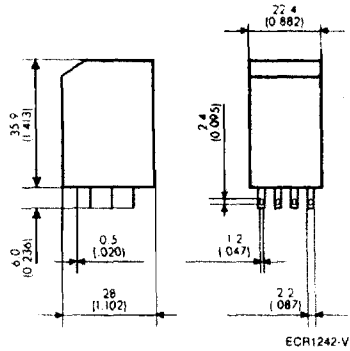

PCB mounting terminals

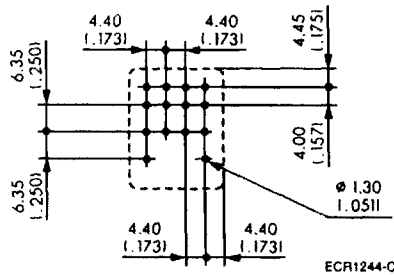
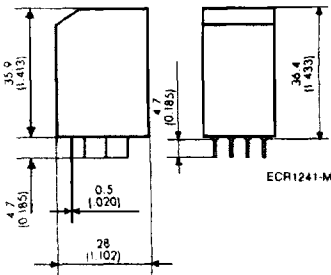

Mounting hole layout
View from the wiring side

All dimensions in mm (inches)

ZT Miniature Relays

Rated voltage	250 Vac
Max. contact voltage	440 Vac
Rated current	5 A
Make current (max. 4 s at 10 % duty cycle)	10 A
Nominal power rating	1250 VA

Contact material: AgNi 90/10

Rated voltage	Voltage range at 20°C	Coil resistance at 20°C	Ordering code	DU	Price each			
					Pcs	DU+	100	500
Vdc	Vdc	Ω						

DC operating voltage

PCB mounting terminals, 4 changeover contacts

▽ 24	18,0 ... 38,4	520 ± 10 %	ZT571024	25					
------	---------------	------------	----------	----	--	--	--	--	--

plug-in terminals, 2 changeover contacts

24	18,0 ... 38,4	520 ± 10 %	ZT270024	25					NEW
----	---------------	------------	----------	----	--	--	--	--	-----

plug-in terminals, 4 changeover contacts

▽ 12	9,0 ... 19,2	160 ± 10 %	ZT570012	25					
▽ 24	18,0 ... 38,4	520 ± 10 %	ZT570024	25					
48	36,0 ... 76,8	2100 ± 10 %	ZT570048	25					NEW
60	45,0 ... 96,0	3300 ± 12 %	ZT570060	25					NEW
110	82,5 ... 176,0	12000 ± 15 %	ZT570110	25					NEW
220	165,0 ... 352,0	44000 ± 15 %	ZT570220	25					NEW

plug-in terminals, 4 changeover contacts, with LED

▽ 24	18,0 ... 38,4	520 ± 10 %	ZT570L24	25					
------	---------------	------------	----------	----	--	--	--	--	--

plug-in terminals, 4 changeover contacts, with LED and recovery diode

▽ 24	18,0 ... 38,6	520 ± 10 %	ZT570LC4	25					
------	---------------	------------	----------	----	--	--	--	--	--

AC operating voltage

plug-in terminals, 2 changeover contacts

24	19,2 ... 26,4	176 ± 10 %	ZT270524	25					NEW
230	184,5 ... 253,0	17100 ± 15 %	ZT270730	25					NEW

plug-in terminals, 4 changeover contacts

12	9,6 ... 13,2	45 ± 10 %	ZT570512	25					NEW
▽ 24	19,2 ... 26,4	176 ± 10 %	ZT570524	25					
48	38,4 ... 52,8	740 ± 10 %	ZT570548	25					NEW
115	92,0 ... 126,5	4300 ± 12 %	ZT570615	25					NEW
▽ 230	184,5 ... 253,0	17100 ± 15 %	ZT570730	25					

plug-in terminals, 4 changeover contacts, with LED

24	19,2 ... 26,4	176 ± 10 %	ZT570R24	25					NEW
▽ 230	184,5 ... 253,0	17100 ± 15 %	ZT570T30	25					

ZT Miniature Relays Accessories

Sockets with screw terminals

ZG78700 und ZG78110

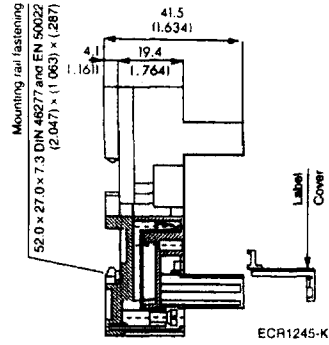
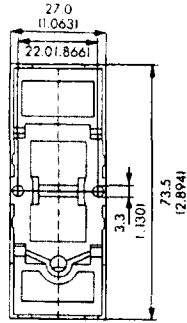

RA78728 incl. retainer

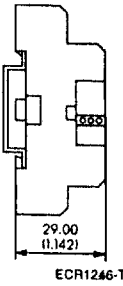
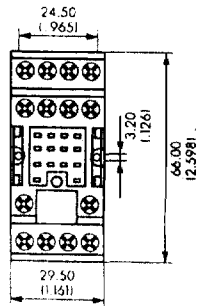

Sockets with soldering terminals

ZG78750

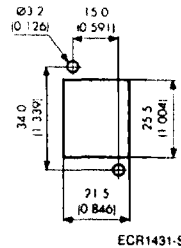
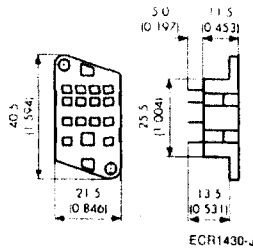

Mounting hole layout

ZT Miniature Relays Accessories

ZG78753

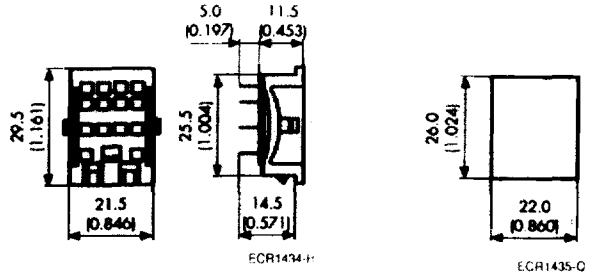

Mounting hole layout

Relays

Sockets with PCB mounting terminals

ZG78752

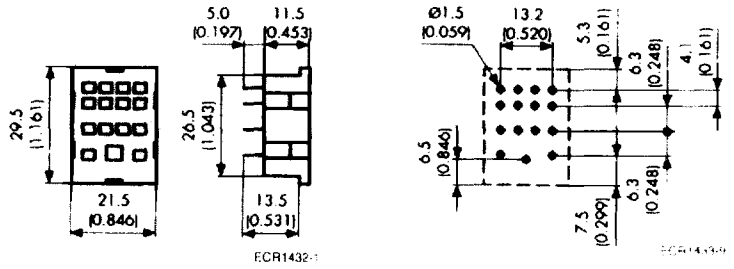

Mounting hole layout
View from the wiring side

ZG78759

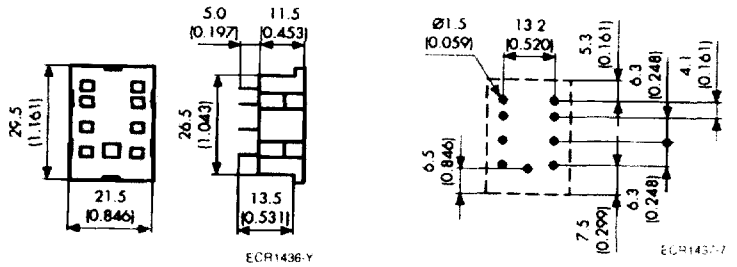

Mounting hole layout
View from the wiring side

ZT Miniature Relays Accessories

Accessories	Ordering code	DU	Price each				
			Pcs	DU+	100+	500+	2000+
Socket with screw terminals, 4 pole, for DIN rail mounting	ZG78700	25					
Socket with screw terminals, 4 pole, for DIN rail mounting wit recovery diode	ZG78110	25					
Retainer for Sockets ZG78700 and ZG78110	ZG28801	25					
Socket with screw terminals, 4 pole, for DIN rail mounting (incl. retainer)	RA78728	10					
Socket with soldering terminals, 4 pole, with mounting holes	ZG78750	25					NEW
Socket with soldering terminals, 4 pole	ZG78753	25					NEW
Socket with PCB mounting terminals, 4 pole	ZG78752	25					NEW
Socket with PCB mounting terminals, 2 pole	ZG78759	25					NEW
Retainer for Sockets ZG78750/752/753 and ZG78759	ZG28800	25					NEW