

GENERAL PURPOSE DUAL JFET OPERATIONAL AMPLIFIERS

- LOW POWER CONSUMPTION
- WIDE COMMON-MODE (UP TO V_{CC}^+) AND DIFFERENTIAL VOLTAGE RANGE
- LOW INPUT BIAS AND OFFSET CURRENT
- OUTPUT SHORT-CIRCUIT PROTECTION
- HIGH INPUT IMPEDANCE J-FET INPUT STAGE
- INTERNAL FREQUENCY COMPENSATION
- LATCH UP FREE OPERATION
- HIGH SLEW RATE : $16V/\mu s$ (typ)

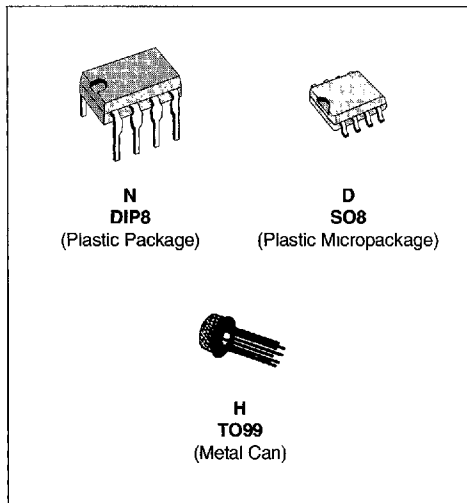

DESCRIPTION

These circuits are high speed J-FET input dual operational amplifiers incorporating well matched, high voltage J-FET and bipolar transistors in a monolithic integrated circuit.

The devices feature high slew rates, low input bias and offset current, and low offset voltage temperature coefficient.

ORDER CODES

Part Number	Temperature	Package		
		H	N	D
MC34002/A/B	0°C, +70°C	•	•	•
MC33002/A/B	-40°C, +105°C	•	•	•
MC35002/A/B	-55°C, +125°C	•	•	•

PIN CONNECTIONS (top views)

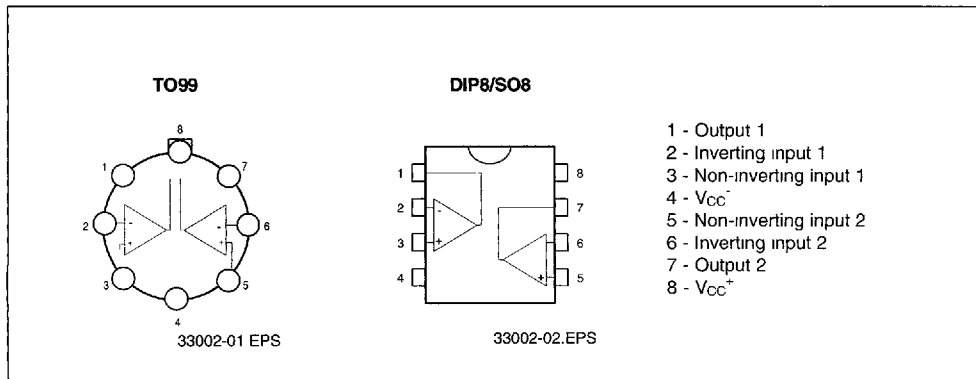

SCHEMATIC DIAGRAM

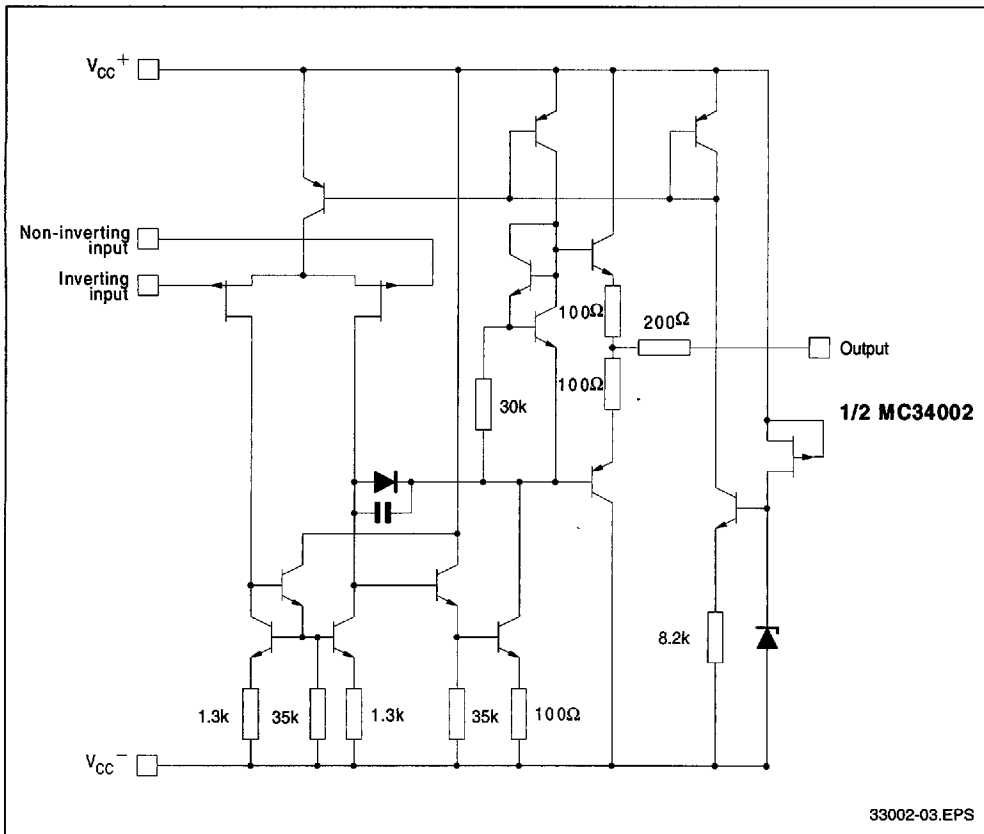

ABSOLUTE MAXIMUM RATINGS

Symbol	Parameter	Value	Unit	
V_{CC}	Supply Voltage - (note 1)	± 18	V	
V_i	Input Voltage - (note 3)	± 15	V	
V_{id}	Differential Input Voltage - (note 2)	± 30	V	
P_{tot}	Power Dissipation	680	mW	
	Output Short-circuit Duration (note 4)	Infinite		
T_{oper}	Operating Free Air Temperature Range	MC34002, A, B MC33002, A, B MC35002, A, B	0 to 70 -40 to 105 -55 to 125	$^{\circ}C$
T_{stg}	Storage Temperature Range		-65 to 150	$^{\circ}C$

- Notes :**
- 1 All voltage values, except differential voltage, are with respect to the zero reference level (ground) of the supply voltages where the zero reference level is the midpoint between V_{CC}^+ and V_{CC}^- .
 - 2 Differential voltages are at the non-inverting input terminal with respect to the inverting input terminal.
 - 3 The magnitude of the input voltage must never exceed the magnitude of the supply voltage or 15 volts, whichever is less.
 - 4 The output may be shorted to ground or to either supply. Temperature and/or supply voltages must be limited to ensure that the dissipation rating is not exceeded.

ELECTRICAL CHARACTERISTICS

V_{CC} = ±15V, T_{amb} = 25°C (unless otherwise specified)

Symbol	Parameter	MC35002A,B MC33002A,B MC34002A,B			MC35002 MC33002 MC34002			Unit
		Min.	Typ.	Max.	Min.	Typ.	Max.	
V _{io}	Input Offset Voltage (R _S ≤ 10kΩ) T _{amb} = 25°C MC35002B, MC34002B, MC33002B MC35002A, MC34002A, MC33002A T _{min} ≤ T _{amb} ≤ T _{max} MC35002B, MC34002B, MC33002B MC35002A, MC34002A, MC33002A		3 1	5 2 7 4		3	10 13	mV
DV _{io}	Input Offset Voltage Drift		10			10		μV/°C
I _{io}	Input Offset Current * T _{amb} = 25°C T _{min} ≤ T _{amb} ≤ T _{max}		5	50 4		5	100 4	pA nA
I _{ib}	Input Bias Current * T _{amb} = 25°C T _{min} ≤ T _{amb} ≤ T _{max}		20	200 20		20	200 20	pA nA
A _{vd}	Large Signal Voltage Gain (R _L = 2kΩ, V _O = ±10V) T _{amb} = 25°C T _{min} ≤ T _{amb} ≤ T _{max}	50 25	200		25 15	200		V/mV
SVR	Supply Voltage Rejection Ratio (R _S ≤ 10kΩ) T _{amb} = 25°C T _{min} ≤ T _{amb} ≤ T _{max}	80 80	86		70 70	86		dB
I _{CC}	Supply Current, per Amp, no Load T _{amb} = 25°C T _{min} ≤ T _{amb} ≤ T _{max}		1.4	2.5 2.8		1.4	2.5 2.8	mA
V _{icm}	Input Common Mode Voltage Range	±11	+15 -12		±11	+15 -12		V
CMR	Common Mode Rejection Ratio (R _S ≤ 10kΩ) T _{amb} = 25°C T _{min} ≤ T _{amb} ≤ T _{max}	80 80	86		70 70	86		dB
I _{os}	Output Short-circuit Current T _{amb} = 25°C T _{min} ≤ T _{amb} ≤ T _{max}	10 10	40	60 60	10 10	40	60 60	mA
±V _{OPP}	Output Voltage Swing T _{amb} = 25°C T _{min} ≤ T _{amb} ≤ T _{max}		10 12 10 12	12 13.5 2kΩ 10kΩ	10 12 10 12	12 13.5		V
SR	Slew Rate (V _{in} = 10V, R _L = 2kΩ, C _L = 100pF, T _{amb} = 25°C, unity gain)	12	16		12	16		V/μs
t _r	Rise Time (V _{in} = 20mV, R _L = 2kΩ, C _L = 100pF, T _{amb} = 25°C, unity gain)		0.1			0.1		μs
K _{OV}	Overshoot (V _{in} = 20mV, R _L = 2kΩ, C _L = 100pF, T _{amb} = 25°C, unity gain)		10			10		%
GBP	Gain Bandwidth Product (f = 100kHz, T _{amb} = 25°C, V _{in} = 10mV, R _L = 2kΩ, C _L = 100pF)	2.5	4		2.5	4		MHz
R _i	Input Resistance		10 ¹²			10 ¹²		Ω
THD	Total Harmonic Distortion (f = 1kHz, A _V = 20dB, R _L = 2kΩ, C _L = 100pF, T _{amb} = 25°C, V _O = 2V _{PP})		0.01			0.01		%
e _n	Equivalent Input Noise Voltage (f = 1kHz, R _S = 100Ω)		15			15		$\frac{nV}{\sqrt{Hz}}$
∅ _m	Phase Margin		45			45		Degrees
V _{O1} /V _{O2}	Channel Separation (A _{vd} = 100)		120			120		dB

* The input bias currents are junction leakage currents which approximately double for every 10°C increase in the junction temperature

MAXIMUM PEAK-TO-PEAK OUTPUT VOLTAGE VERSUS FREQUENCY

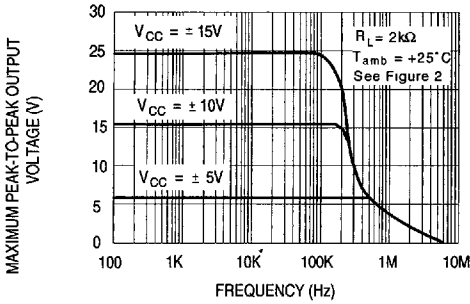

33002-04.EPS

MAXIMUM PEAK-TO-PEAK OUTPUT VOLTAGE VERSUS FREQUENCY

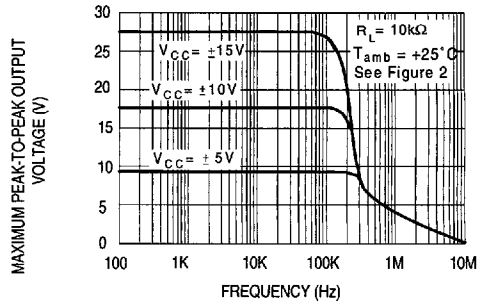

33002-05.EPS

MAXIMUM PEAK-TO-PEAK OUTPUT VOLTAGE VERSUS FREQUENCY

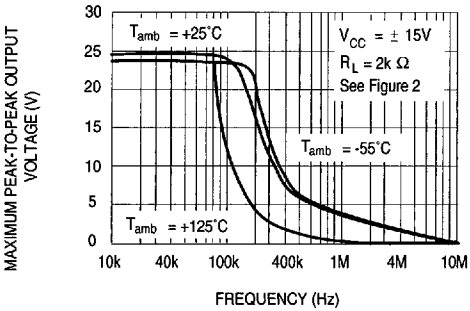

33002-06.EPS

MAXIMUM PEAK-TO-PEAK OUTPUT VOLTAGE VERSUS FREE AIR TEMP.

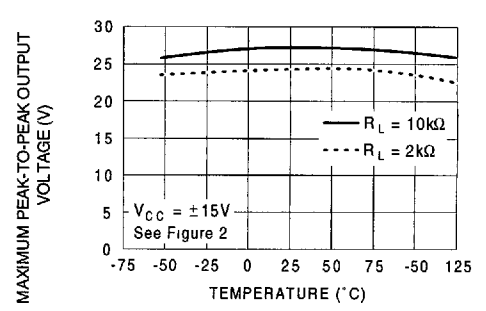

33002-07.EPS

MAXIMUM PEAK-TO-PEAK OUTPUT VOLTAGE VERSUS LOAD RESISTANCE

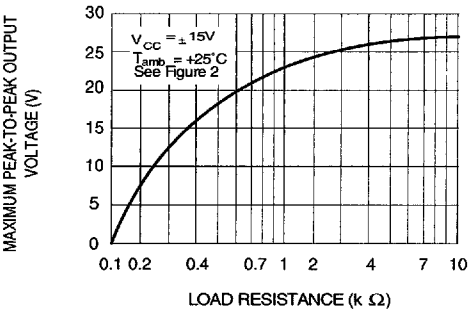

33002-08.EPS

MAXIMUM PEAK-TO-PEAK OUTPUT VOLTAGE VERSUS SUPPLY VOLTAGE

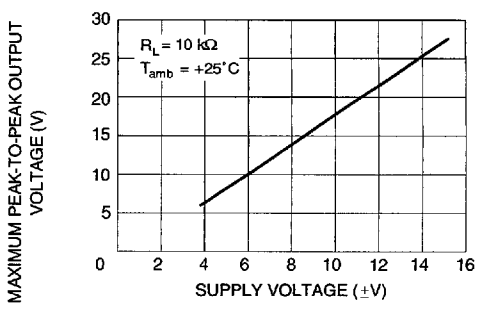

33002-09.EPS

INPUT BIAS CURRENT VERSUS FREE AIR TEMPERATURE

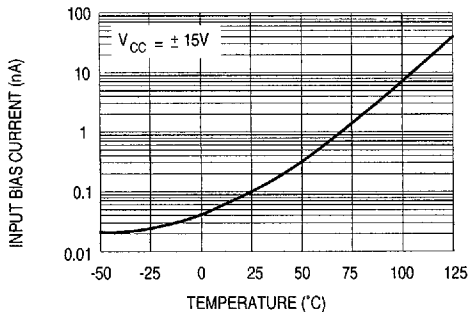

33002-10.EPS

LARGE SIGNAL DIFFERENTIAL VOLTAGE AMPLIFICATION VERSUS FREE AIR TEMPERATURE

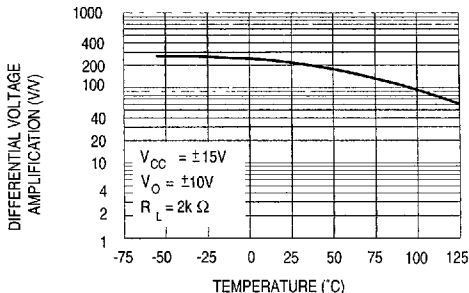

33002-11.EPS

LARGE SIGNAL DIFFERENTIAL VOLTAGE AMPLIFICATION AND PHASE SHIFT VERSUS FREQUENCY

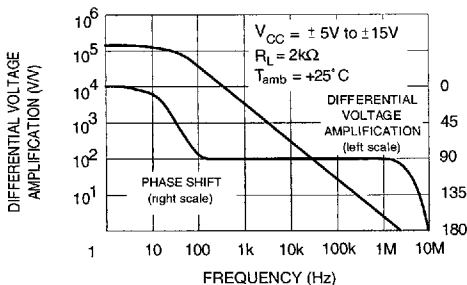

33002-12.EPS

TOTAL POWER DISSIPATION VERSUS FREE AIR TEMPERATURE

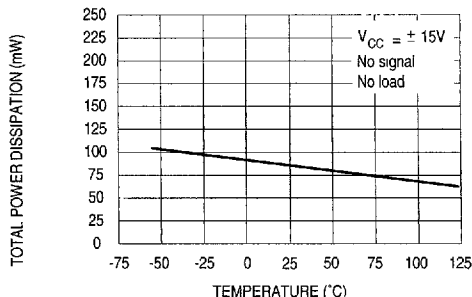

33002-13.EPS

SUPPLY CURRENT PER AMPLIFIER VERSUS FREE AIR TEMPERATURE

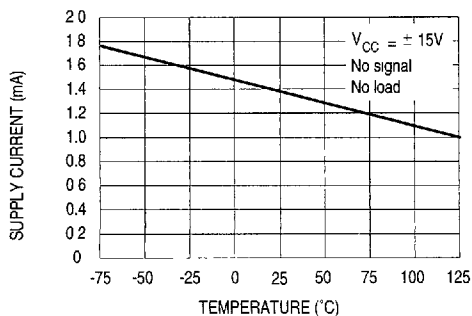

33002-14.EPS

SUPPLY CURRENT PER AMPLIFIER VERSUS SUPPLY VOLTAGE

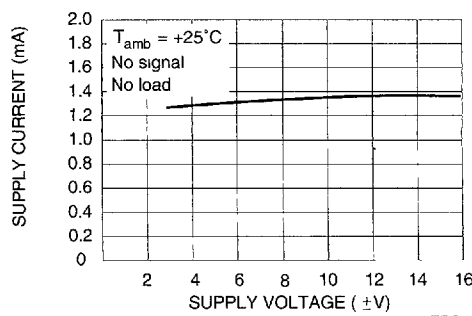

33002-15.EPS

**COMMON MODE REJECTION RATIO
VERSUS FREE AIR TEMPERATURE**

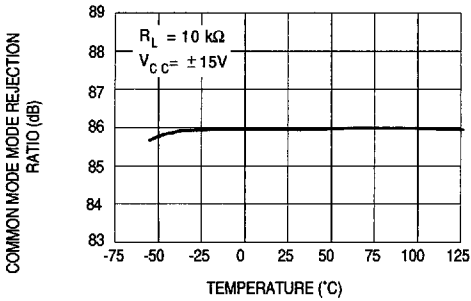

33002-16.EPS

**VOLTAGE FOLLOWER LARGE SIGNAL
PULSE RESPONSE**

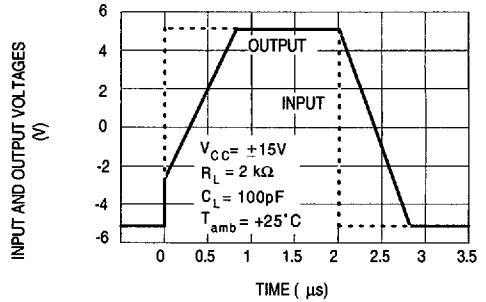

33002-17.EPS

**OUTPUT VOLTAGE VERSUS
ELAPSED TIME**

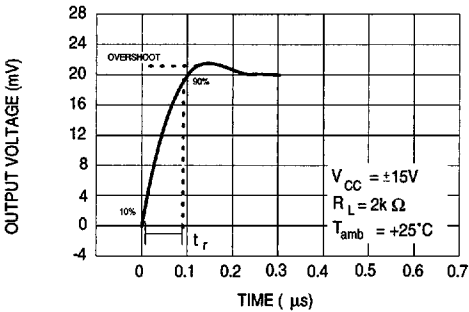

33002-18.EPS

**EQUIVALENT INPUT NOISE VOLTAGE
VERSUS FREQUENCY**

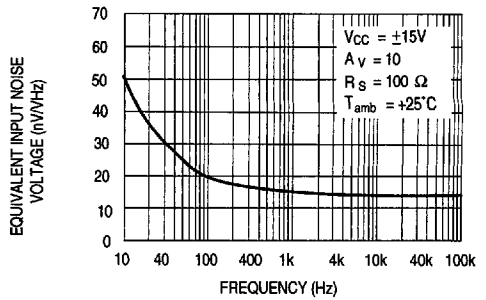

33002-19.EPS

**TOTAL HARMONIC DISTORTION VERSUS
FREQUENCY**

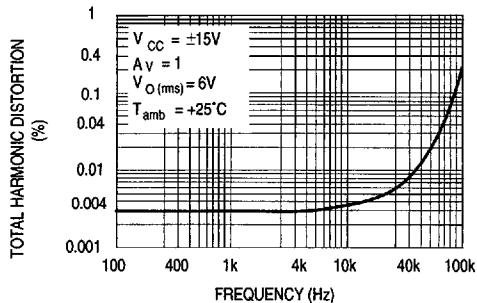

33002-20.EPS

PARAMETER MEASUREMENT INFORMATION

Figure 1 : Voltage Follower

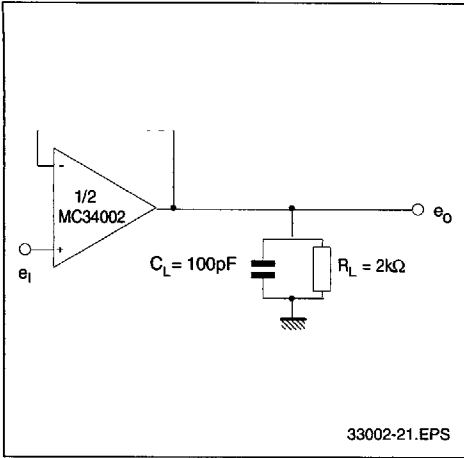
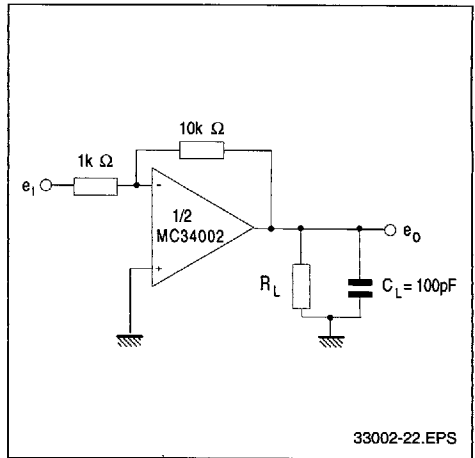

Figure 2 : Gain-of-10 Inverting Amplifier



TYPICAL APPLICATION

100KHz QUADRUPLE OSCILLATOR

