

# LM1575/LM2575/LM2575HV SIMPLE SWITCHER® 1A Step-Down Voltage Regulator

## General Description

The LM2575 series of regulators are monolithic integrated circuits that provide all the active functions for a step-down (buck) switching regulator, capable of driving a 1A load with excellent line and load regulation. These devices are available in fixed output voltages of 3.3V, 5V, 12V, 15V, and an adjustable output version.

Requiring a minimum number of external components, these regulators are simple to use and include internal frequency compensation and a fixed-frequency oscillator.

The LM2575 series offers a high-efficiency replacement for popular three-terminal linear regulators. It substantially reduces the size of the heat sink, and in many cases no heat sink is required.

A standard series of inductors optimized for use with the LM2575 are available from several different manufacturers. This feature greatly simplifies the design of switch-mode power supplies.

Other features include a guaranteed  $\pm 4\%$  tolerance on output voltage within specified input voltages and output load conditions, and  $\pm 10\%$  on the oscillator frequency. External shutdown is included, featuring 50  $\mu\text{A}$  (typical) standby current. The output switch includes cycle-by-cycle current limiting, as well as thermal shutdown for full protection under fault conditions.

## Features

- 3.3V, 5V, 12V, 15V, and adjustable output versions
- Adjustable version output voltage range, 1.23V to 37V (57V for HV version)  $\pm 4\%$  max over line and load conditions
- Guaranteed 1A output current
- Wide input voltage range, 40V up to 60V for HV version
- Requires only 4 external components
- 52 kHz fixed frequency internal oscillator
- TTL shutdown capability, low power standby mode
- High efficiency
- Uses readily available standard inductors
- Thermal shutdown and current limit protection
- P+ Product Enhancement tested

## Applications

- Simple high-efficiency step-down (buck) regulator
- Efficient pre-regulator for linear regulators
- On-card switching regulators
- Positive to negative converter (Buck-Boost)

## Typical Application

(Fixed Output Voltage Versions)

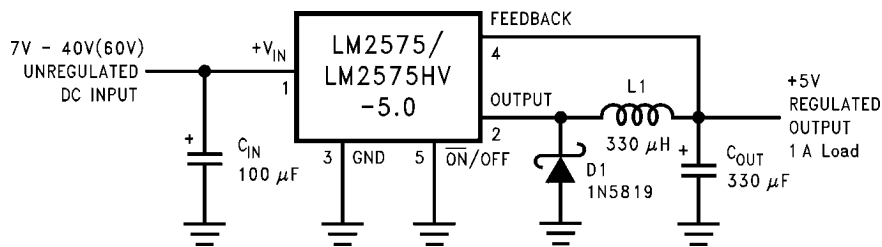

1147501

**Note:** Pin numbers are for the TO-220 package.

## Block Diagram and Typical Application

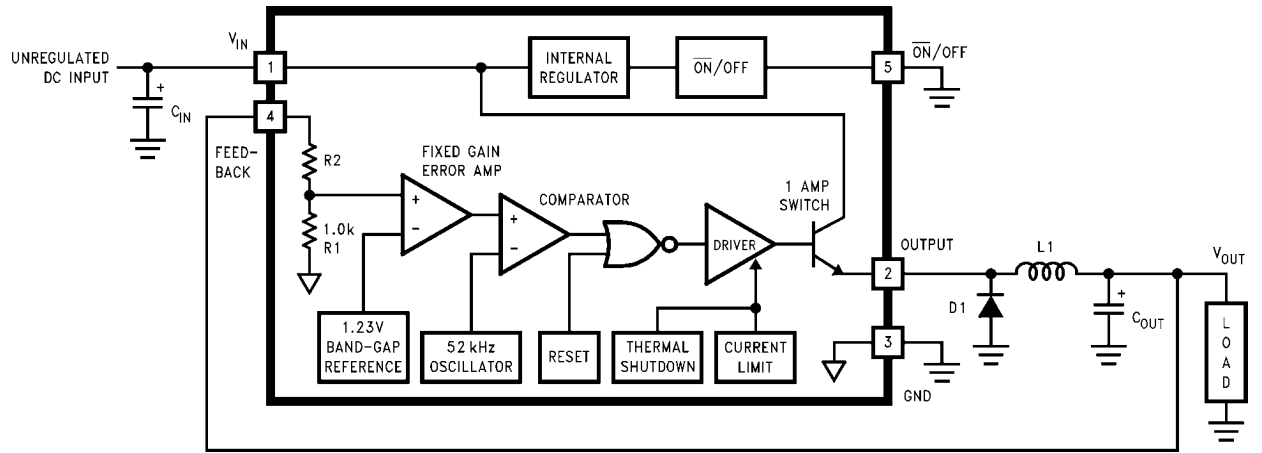

1147502

3.3V, R2 = 1.7k  
 5V, R2 = 3.1k  
 12V, R2 = 8.84k  
 15V, R2 = 11.3k  
 For ADJ. Version  
 R1 = Open, R2 = 0Ω

**Note:** Pin numbers are for the TO-220 package.

FIGURE 1.

# Connection Diagrams

(XX indicates output voltage option. See Ordering Information table for complete part number.)

## Straight Leads 5-Lead TO-220 (T)

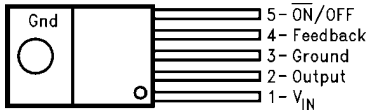

1147522

**Top View**  
LM2575T-XX or LM2575HVT-XX  
See NS Package Number T05A

## Bent, Staggered Leads 5-Lead TO-220 (T)

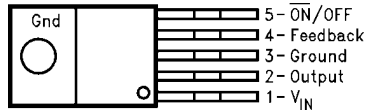

1147523

**Top View**

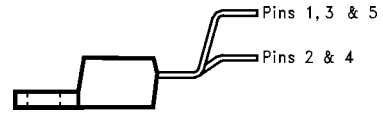

1147524

**Side View**  
LM2575T-XX Flow LB03 or  
LM2575HVT-XX Flow LB03  
See NS Package Number T05D

## 16-Lead DIP (N or J)

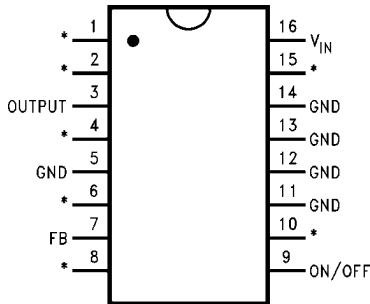

1147525

\*No Internal Connection

**Top View**  
LM2575N-XX or LM2575HVN-XX  
See NS Package Number N16A  
LM1575J-XX-QML  
See NS Package Number J16A

## 24-Lead Surface Mount (M)

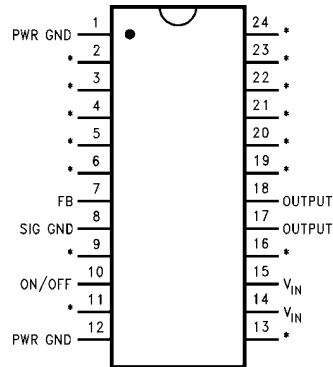

1147526

\*No Internal Connection

**Top View**  
LM2575M-XX or LM2575HVM-XX  
See NS Package Number M24B

## TO-263(S) 5-Lead Surface-Mount Package

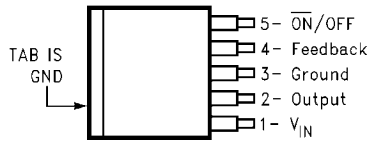

1147529

**Top View**



1147530

**Side View**  
LM2575S-XX or LM2575HVS-XX  
See NS Package Number TS5B

## Ordering Information

Package Type	NSC Package Number	Standard Voltage Rating (40V)	High Voltage Rating (60V)	Temperature Range
5-Lead TO-220 Straight Leads	T05A	LM2575T-3.3 LM2575T-5.0 LM2575T-12 LM2575T-15 LM2575T-ADJ	LM2575HVT-3.3 LM2575HVT-5.0 LM2575HVT-12 LM2575HVT-15 LM2575HVT-ADJ	-40°C ≤ T <sub>J</sub> ≤ +125°C
5-Lead TO-220 Bent and Staggered Leads	T05D	LM2575T-3.3 Flow LB03 LM2575T-5.0 Flow LB03 LM2575T-12 Flow LB03 LM2575T-15 Flow LB03 LM2575T-ADJ Flow LB03	LM2575HVT-3.3 Flow LB03 LM2575HVT-5.0 Flow LB03 LM2575HVT-12 Flow LB03 LM2575HVT-15 Flow LB03 LM2575HVT-ADJ Flow LB03	
16-Pin Molded DIP	N16A	LM2575N-5.0 LM2575N-12 LM2575N-15 LM2575N-ADJ	LM2575HVN-5.0 LM2575HVN-12 LM2575HVN-15 LM2575HVN-ADJ	
24-Pin Surface Mount	M24B	LM2575M-5.0 LM2575M-12 LM2575M-15 LM2575M-ADJ	LM2575HVM-5.0 LM2575HVM-12 LM2575HVM-15 LM2575HVM-ADJ	
5-Lead TO-263 Surface Mount	TS5B	LM2575S-3.3 LM2575S-5.0 LM2575S-12 LM2575S-15 LM2575S-ADJ	LM2575HVS-3.3 LM2575HVS-5.0 LM2575HVS-12 LM2575HVS-15 LM2575HVS-ADJ	
16-Pin Ceramic DIP	J16A	LM1575J-3.3-QML LM1575J-5.0-QML LM1575J-12-QML LM1575J-15-QML LM1575J-ADJ-QML		-55°C ≤ T <sub>J</sub> ≤ +150°C

**Absolute Maximum Ratings** (Note 1)

If Military/Aerospace specified devices are required, please contact the National Semiconductor Sales Office/Distributors for availability and specifications.

Maximum Supply Voltage	
LM1575/LM2575	45V
LM2575HV	63V
$\overline{\text{ON}}$ /OFF Pin Input Voltage	$-0.3V \leq V \leq +V_{\text{IN}}$
Output Voltage to Ground (Steady State)	-1V
Power Dissipation	Internally Limited
Storage Temperature Range	$-65^{\circ}\text{C}$ to $+150^{\circ}\text{C}$
Maximum Junction Temperature	$150^{\circ}\text{C}$

Minimum ESD Rating

(C = 100 pF, R = 1.5 k $\Omega$ ) 2 kV

Lead Temperature

(Soldering, 10 sec.)  $260^{\circ}\text{C}$ **Operating Ratings**

Temperature Range

LM1575  $-55^{\circ}\text{C} \leq T_{\text{J}} \leq +150^{\circ}\text{C}$ LM2575/LM2575HV  $-40^{\circ}\text{C} \leq T_{\text{J}} \leq +125^{\circ}\text{C}$ 

Supply Voltage

LM1575/LM2575 40V

LM2575HV 60V

**LM1575-3.3, LM2575-3.3, LM2575HV-3.3**  
**Electrical Characteristics**

Specifications with standard type face are for  $T_{\text{J}} = 25^{\circ}\text{C}$ , and those with **boldface type** apply over full Operating Temperature Range.

Symbol	Parameter	Conditions	Typ	LM1575-3.3	LM2575-3.3 LM2575HV-3.3	Units (Limits)
				Limit (Note 2)	Limit (Note 3)	
<b>SYSTEM PARAMETERS</b> (Note 4) Test Circuit <i>Figure 2</i>						
$V_{\text{OUT}}$	Output Voltage	$V_{\text{IN}} = 12\text{V}$ , $I_{\text{LOAD}} = 0.2\text{A}$ Circuit of <i>Figure 2</i>	3.3	3.267 3.333	3.234 3.366	V V(Min) V(Max)
$V_{\text{OUT}}$	Output Voltage LM1575/LM2575	$4.75\text{V} \leq V_{\text{IN}} \leq 40\text{V}$ , $0.2\text{A} \leq I_{\text{LOAD}} \leq 1\text{A}$ Circuit of <i>Figure 2</i>	3.3	3.200/ <b>3.168</b> 3.400/ <b>3.432</b>	3.168/ <b>3.135</b> 3.432/ <b>3.465</b>	V V(Min) V(Max)
$V_{\text{OUT}}$	Output Voltage LM2575HV	$4.75\text{V} \leq V_{\text{IN}} \leq 60\text{V}$ , $0.2\text{A} \leq I_{\text{LOAD}} \leq 1\text{A}$ Circuit of <i>Figure 2</i>	3.3	3.200/ <b>3.168</b> 3.416/ <b>3.450</b>	3.168/ <b>3.135</b> 3.450/ <b>3.482</b>	V V(Min) V(Max)
$\eta$	Efficiency	$V_{\text{IN}} = 12\text{V}$ , $I_{\text{LOAD}} = 1\text{A}$	75			%

**LM1575-5.0, LM2575-5.0, LM2575HV-5.0**  
**Electrical Characteristics**

Specifications with standard type face are for  $T_{\text{J}} = 25^{\circ}\text{C}$ , and those with **boldface type** apply over full Operating Temperature Range.

Symbol	Parameter	Conditions	Typ	LM1575-5.0	LM2575-5.0 LM2575HV-5.0	Units (Limits)
				Limit (Note 2)	Limit (Note 3)	
<b>SYSTEM PARAMETERS</b> (Note 4) Test Circuit <i>Figure 2</i>						
$V_{\text{OUT}}$	Output Voltage	$V_{\text{IN}} = 12\text{V}$ , $I_{\text{LOAD}} = 0.2\text{A}$ Circuit of <i>Figure 2</i>	5.0	4.950 5.050	4.900 5.100	V V(Min) V(Max)
$V_{\text{OUT}}$	Output Voltage LM1575/LM2575	$0.2\text{A} \leq I_{\text{LOAD}} \leq 1\text{A}$ , $8\text{V} \leq V_{\text{IN}} \leq 40\text{V}$ Circuit of <i>Figure 2</i>	5.0	4.850/ <b>4.800</b> 5.150/ <b>5.200</b>	4.800/ <b>4.750</b> 5.200/ <b>5.250</b>	V V(Min) V(Max)

Symbol	Parameter	Conditions	Typ	LM1575-5.0	LM2575-5.0 LM2575HV-5.0	Units (Limits)
				Limit (Note 2)	Limit (Note 3)	
$V_{OUT}$	Output Voltage LM2575HV	$0.2A \leq I_{LOAD} \leq 1A$ , $8V \leq V_{IN} \leq 60V$ Circuit of <i>Figure 2</i>	5.0	4.850/ <b>4.800</b> 5.175/ <b>5.225</b>	4.800/ <b>4.750</b> 5.225/ <b>5.275</b>	V V(Min) V(Max)
$\eta$	Efficiency	$V_{IN} = 12V$ , $I_{LOAD} = 1A$	77			%

## LM1575-12, LM2575-12, LM2575HV-12 Electrical Characteristics

Specifications with standard type face are for  $T_J = 25^\circ C$ , and those with **boldface type** apply over full Operating Temperature Range .

Symbol	Parameter	Conditions	Typ	LM1575-12	LM2575-12 LM2575HV-12	Units (Limits)
				Limit (Note 2)	Limit (Note 3)	

### SYSTEM PARAMETERS (Note 4) Test Circuit *Figure 2*

$V_{OUT}$	Output Voltage	$V_{IN} = 25V$ , $I_{LOAD} = 0.2A$ Circuit of <i>Figure 2</i>	12	11.88 12.12	11.76 12.24	V V(Min) V(Max)
$V_{OUT}$	Output Voltage LM1575/LM2575	$0.2A \leq I_{LOAD} \leq 1A$ , $15V \leq V_{IN} \leq 40V$ Circuit of <i>Figure 2</i>	12	11.64/ <b>11.52</b> 12.36/ <b>12.48</b>	11.52/ <b>11.40</b> 12.48/ <b>12.60</b>	V V(Min) V(Max)
$V_{OUT}$	Output Voltage LM2575HV	$0.2A \leq I_{LOAD} \leq 1A$ , $15V \leq V_{IN} \leq 60V$ Circuit of <i>Figure 2</i>	12	11.64/ <b>11.52</b> 12.42/ <b>12.54</b>	11.52/ <b>11.40</b> 12.54/ <b>12.66</b>	V V(Min) V(Max)
$\eta$	Efficiency	$V_{IN} = 15V$ , $I_{LOAD} = 1A$	88			%

## LM1575-15, LM2575-15, LM2575HV-15 Electrical Characteristics

Specifications with standard type face are for  $T_J = 25^\circ C$ , and those with **boldface type** apply over full Operating Temperature Range .

Symbol	Parameter	Conditions	Typ	LM1575-15	LM2575-15 LM2575HV-15	Units (Limits)
				Limit (Note 2)	Limit (Note 3)	

### SYSTEM PARAMETERS (Note 4) Test Circuit *Figure 2*

$V_{OUT}$	Output Voltage	$V_{IN} = 30V$ , $I_{LOAD} = 0.2A$ Circuit of <i>Figure 2</i>	15	14.85 15.15	14.70 15.30	V V(Min) V(Max)
$V_{OUT}$	Output Voltage LM1575/LM2575	$0.2A \leq I_{LOAD} \leq 1A$ , $18V \leq V_{IN} \leq 40V$ Circuit of <i>Figure 2</i>	15	14.55/ <b>14.40</b> 15.45/ <b>15.60</b>	14.40/ <b>14.25</b> 15.60/ <b>15.75</b>	V V(Min) V(Max)
$V_{OUT}$	Output Voltage LM2575HV	$0.2A \leq I_{LOAD} \leq 1A$ , $18V \leq V_{IN} \leq 60V$ Circuit of <i>Figure 2</i>	15	14.55/ <b>14.40</b> 15.525/ <b>15.675</b>	14.40/ <b>14.25</b> 15.68/ <b>15.83</b>	V V(Min) V(Max)
$\eta$	Efficiency	$V_{IN} = 18V$ , $I_{LOAD} = 1A$	88			%

## LM1575-ADJ, LM2575-ADJ, LM2575HV-ADJ Electrical Characteristics

Specifications with standard type face are for  $T_J = 25^\circ\text{C}$ , and those with **boldface type** apply over **full Operating Temperature Range**.

Symbol	Parameter	Conditions	Typ	LM1575-ADJ	LM2575-ADJ LM2575HV-ADJ	Units (Limits)
				Limit (Note 2)	Limit (Note 3)	
<b>SYSTEM PARAMETERS</b> (Note 4) Test Circuit <i>Figure 2</i>						
$V_{OUT}$	Feedback Voltage	$V_{IN} = 12\text{V}$ , $I_{LOAD} = 0.2\text{A}$ $V_{OUT} = 5\text{V}$ Circuit of <i>Figure 2</i>	1.230	1.217 1.243	1.217 1.243	V V(Min) V(Max)
$V_{OUT}$	Feedback Voltage LM1575/LM2575	$0.2\text{A} \leq I_{LOAD} \leq 1\text{A}$ , $8\text{V} \leq V_{IN} \leq 40\text{V}$ $V_{OUT} = 5\text{V}$ , Circuit of <i>Figure 2</i>	1.230	1.205/ <b>1.193</b> 1.255/ <b>1.267</b>	1.193/ <b>1.180</b> 1.267/ <b>1.280</b>	V V(Min) V(Max)
$V_{OUT}$	Feedback Voltage LM2575HV	$0.2\text{A} \leq I_{LOAD} \leq 1\text{A}$ , $8\text{V} \leq V_{IN} \leq 60\text{V}$ $V_{OUT} = 5\text{V}$ , Circuit of <i>Figure 2</i>	1.230	1.205/ <b>1.193</b> 1.261/ <b>1.273</b>	1.193/ <b>1.180</b> 1.273/ <b>1.286</b>	V V(Min) V(Max)
$\eta$	Efficiency	$V_{IN} = 12\text{V}$ , $I_{LOAD} = 1\text{A}$ , $V_{OUT} = 5\text{V}$	77			%

## All Output Voltage Versions Electrical Characteristics

Specifications with standard type face are for  $T_J = 25^\circ\text{C}$ , and those with **boldface type** apply over **full Operating Temperature Range**. Unless otherwise specified,  $V_{IN} = 12\text{V}$  for the 3.3V, 5V, and Adjustable version,  $V_{IN} = 25\text{V}$  for the 12V version, and  $V_{IN} = 30\text{V}$  for the 15V version.  $I_{LOAD} = 200\text{mA}$ .

Symbol	Parameter	Conditions	Typ	LM1575-XX	LM2575-XX LM2575HV-XX	Units (Limits)
				Limit (Note 2)	Limit (Note 3)	
<b>DEVICE PARAMETERS</b>						
$I_b$	Feedback Bias Current	$V_{OUT} = 5\text{V}$ (Adjustable Version Only)	50	100/ <b>500</b>	100/ <b>500</b>	nA
$f_o$	Oscillator Frequency	(Note 13)	52	47/ <b>43</b> 58/ <b>62</b>	47/ <b>42</b> 58/ <b>63</b>	kHz kHz(Min) kHz(Max)
$V_{SAT}$	Saturation Voltage	$I_{OUT} = 1\text{A}$ (Note 5)	0.9	1.2/ <b>1.4</b>	1.2/ <b>1.4</b>	V V(Max)
DC	Max Duty Cycle (ON)	(Note 6)	98	93	93	% %(Min)
$I_{CL}$	Current Limit	Peak Current (Notes 5, 13)	2.2	1.7/ <b>1.3</b> 3.0/ <b>3.2</b>	1.7/ <b>1.3</b> 3.0/ <b>3.2</b>	A A(Min) A(Max)
$I_L$	Output Leakage Current	(Notes 7, 8) Output = 0V Output = -1V Output = -1V	7.5	2 30	2 30	mA(Max) mA mA(Max)
$I_Q$	Quiescent Current	(Note 7)	5	10/ <b>12</b>	10	mA mA(Max)
$I_{STBY}$	Standby Quiescent Current	$\overline{ON}$ /OFF Pin = 5V (OFF)	50	200/ <b>500</b>	200	$\mu\text{A}$ $\mu\text{A}$ (Max)

Symbol	Parameter	Conditions	Typ	LM1575-XX	LM2575-XX LM2575HV-XX	Units (Limits)
				Limit (Note 2)	Limit (Note 3)	
$\theta_{JA}$	Thermal Resistance	T Package, Junction to Ambient (Note 9)	65			°C/W
$\theta_{JA}$		T Package, Junction to Ambient (Note 10)	45			
$\theta_{JC}$		T Package, Junction to Case	2			
$\theta_{JA}$		N Package, Junction to Ambient (Note 11)	85			
$\theta_{JA}$		M Package, Junction to Ambient (Note 11)	100			
$\theta_{JA}$		S Package, Junction to Ambient (Note 12)	37			

**ON /OFF CONTROL Test Circuit** *Figure 2*

$V_{IH}$	ON /OFF Pin Logic Input Level	$V_{OUT} = 0V$	1.4	<b>2.2/2.4</b>	<b>2.2/2.4</b>	V(Min)
$V_{IL}$		$V_{OUT} = \text{Nominal Output Voltage}$	1.2	<b>1.0/0.8</b>	<b>1.0/0.8</b>	V(Max)
$I_{IH}$	ON /OFF Pin Input Current	ON /OFF Pin = 5V (OFF)	12	30	30	$\mu A$ $\mu A(\text{Max})$
		ON /OFF Pin = 0V (ON)	0	10	10	$\mu A$ $\mu A(\text{Max})$

**Note 1:** Absolute Maximum Ratings indicate limits beyond which damage to the device may occur. Operating Ratings indicate conditions for which the device is intended to be functional, but do not guarantee specific performance limits. For guaranteed specifications and test conditions, see the Electrical Characteristics.

**Note 2:** All limits guaranteed at room temperature (standard type face) and at **temperature extremes (bold type face)**. All limits are used to calculate Average Outgoing Quality Level, and all are 100% production tested.

**Note 3:** All limits guaranteed at room temperature (standard type face) and at **temperature extremes (bold type face)**. All room temperature limits are 100% production tested. All limits at **temperature extremes** are guaranteed via correlation using standard Statistical Quality Control (SQC) methods.

**Note 4:** External components such as the catch diode, inductor, input and output capacitors can affect switching regulator system performance. When the LM1575/LM2575 is used as shown in the *Figure 2* test circuit, system performance will be as shown in system parameters section of Electrical Characteristics.

**Note 5:** Output (pin 2) sourcing current. No diode, inductor or capacitor connected to output pin.

**Note 6:** Feedback (pin 4) removed from output and connected to 0V.

**Note 7:** Feedback (pin 4) removed from output and connected to +12V for the Adjustable, 3.3V, and 5V versions, and +25V for the 12V and 15V versions, to force the output transistor OFF.

**Note 8:**  $V_{IN} = 40V$  (60V for the high voltage version).

**Note 9:** Junction to ambient thermal resistance (no external heat sink) for the 5 lead TO-220 package mounted vertically, with ½ inch leads in a socket, or on a PC board with minimum copper area.

**Note 10:** Junction to ambient thermal resistance (no external heat sink) for the 5 lead TO-220 package mounted vertically, with ½ inch leads soldered to a PC board containing approximately 4 square inches of copper area surrounding the leads.

**Note 11:** Junction to ambient thermal resistance with approximately 1 square inch of pc board copper surrounding the leads. Additional copper area will lower thermal resistance further. See thermal model in Switchers made Simple software.

**Note 12:** If the TO-263 package is used, the thermal resistance can be reduced by increasing the PC board copper area thermally connected to the package: Using 0.5 square inches of copper area,  $\theta_{JA}$  is 50°C/W; with 1 square inch of copper area,  $\theta_{JA}$  is 37°C/W; and with 1.6 or more square inches of copper area,  $\theta_{JA}$  is 32°C/W.

**Note 13:** The oscillator frequency reduces to approximately 18 kHz in the event of an output short or an overload which causes the regulated output voltage to drop approximately 40% from the nominal output voltage. This self protection feature lowers the average power dissipation of the IC by lowering the minimum duty cycle from 5% down to approximately 2%.

**Note 14:** Refer to RETS LM1575J for current revision of military RETS/SMD.



# Typical Performance Characteristics (Circuit of Figure 2)

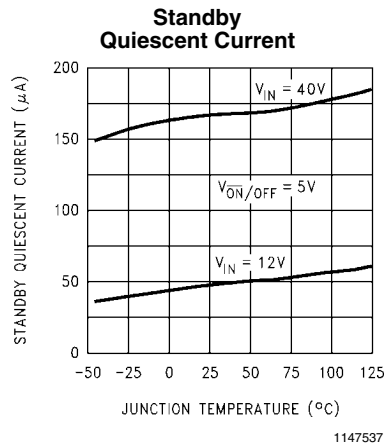
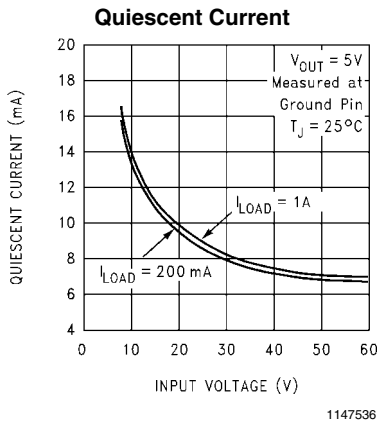
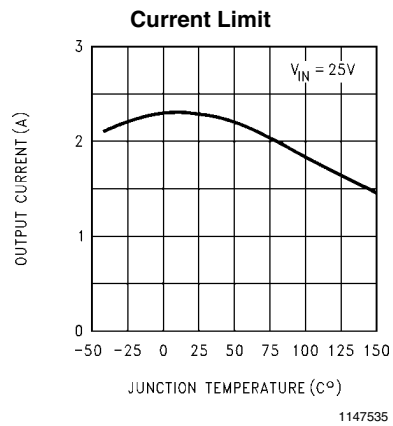
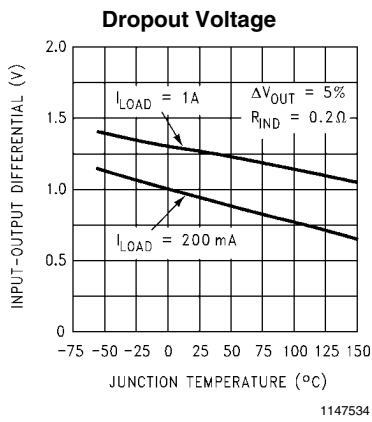
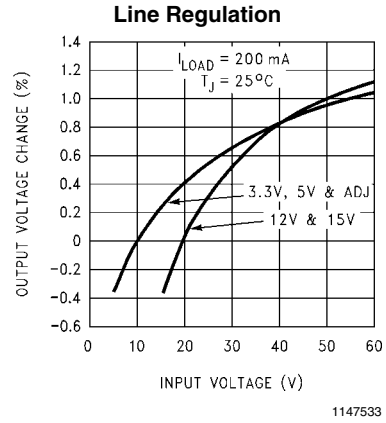
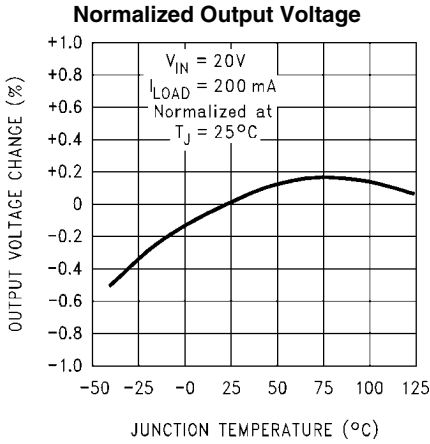

**Oscillator Frequency**

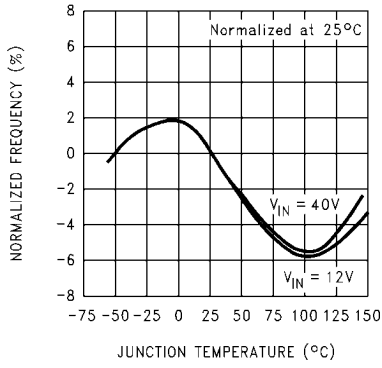

1147538

**Switch Saturation Voltage**

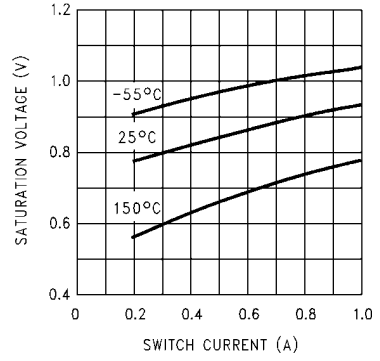

1147539

**Efficiency**

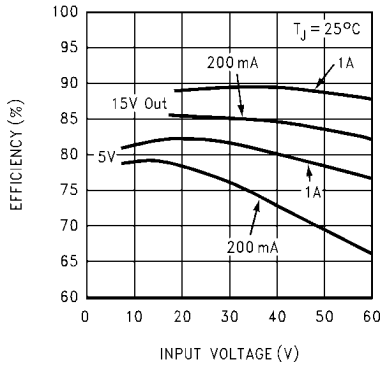

1147540

**Minimum Operating Voltage**

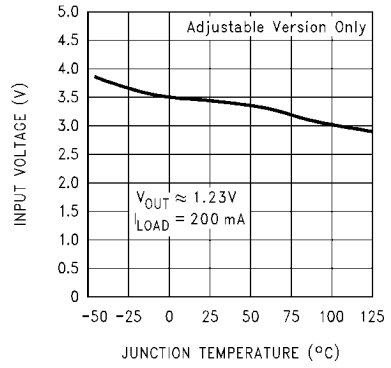

1147541

**Quiescent Current vs Duty Cycle**

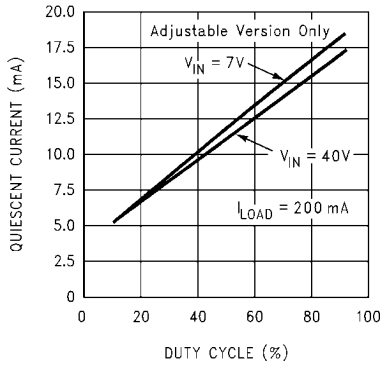

1147542

**Feedback Voltage vs Duty Cycle**

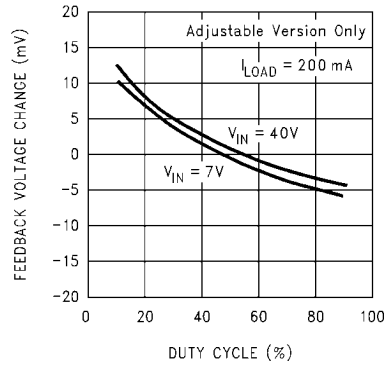

1147543

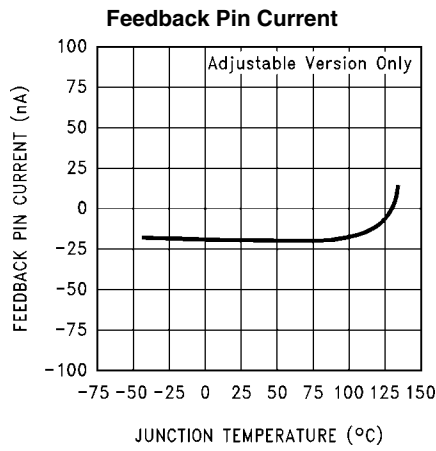

1147505

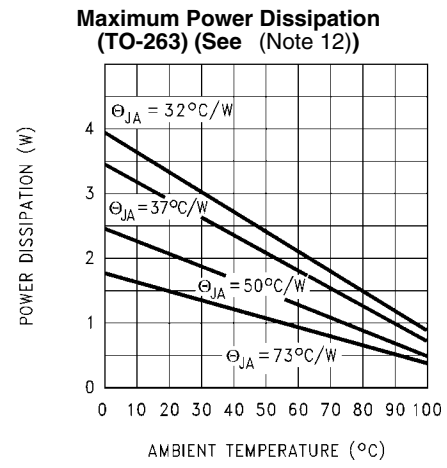

1147528

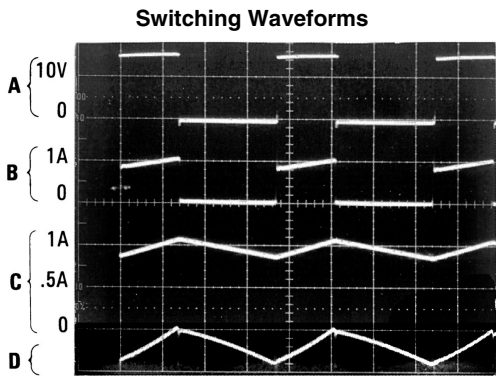

1147506

$V_{OUT} = 5V$   
 A: Output Pin Voltage, 10V/div  
 B: Output Pin Current, 1A/div  
 C: Inductor Current, 0.5A/div  
 D: Output Ripple Voltage, 20 mV/div, AC-Coupled  
**Horizontal Time Base: 5  $\mu\text{s}$ /div**

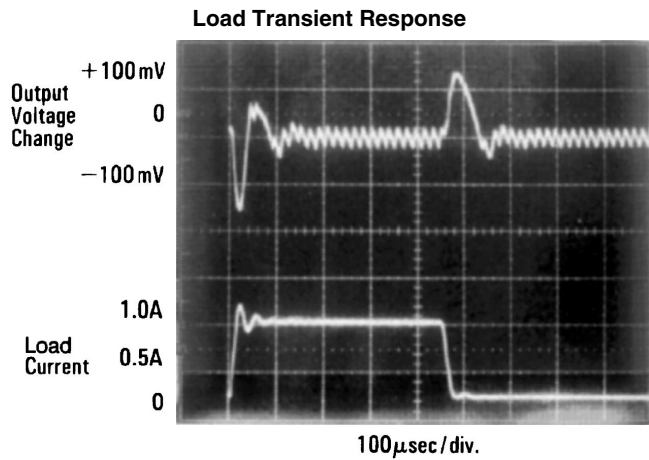

1147507

## Test Circuit and Layout Guidelines

As in any switching regulator, layout is very important. Rapidly switching currents associated with wiring inductance generate voltage transients which can cause problems. For minimal inductance and ground loops, the length of the leads indicated

by heavy lines should be kept as short as possible. Single-point grounding (as indicated) or ground plane construction should be used for best results. When using the Adjustable version, physically locate the programming resistors near the regulator, to keep the sensitive feedback wiring short.

### Fixed Output Voltage Versions

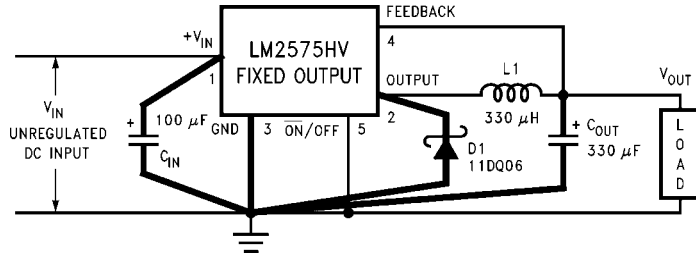

1147508

C<sub>IN</sub> — 100 µF, 75V, Aluminum Electrolytic

C<sub>OUT</sub> — 330 µF, 25V, Aluminum Electrolytic

D1 — Schottky, 11DQ06

L1 — 330 µH, PE-52627 (for 5V in, 3.3V out, use 100 µH, PE-92108)

### Adjustable Output Voltage Version

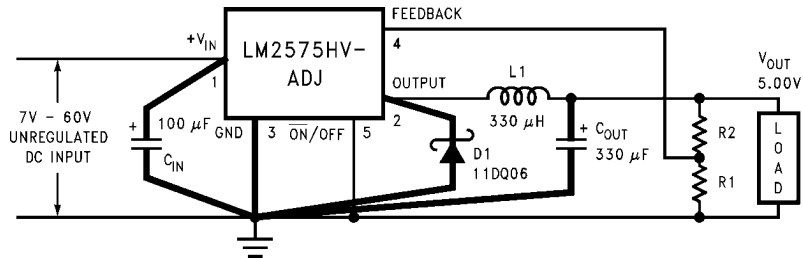

1147509

$$V_{OUT} = V_{REF} \left( 1 + \frac{R2}{R1} \right)$$

$$R2 = R1 \left( \frac{V_{OUT}}{V_{REF}} - 1 \right)$$

where V<sub>REF</sub> = 1.23V, R1 between 1k and 5k.

R1 — 2k, 0.1%

R2 — 6.12k, 0.1%

**Note:** Pin numbers are for the TO-220 package.

FIGURE 2.

## LM2575 Series Buck Regulator Design Procedure

PROCEDURE (Fixed Output Voltage Versions)	EXAMPLE (Fixed Output Voltage Versions)
<p><b>Given:</b>  <math>V_{OUT}</math> = Regulated Output Voltage (3.3V, 5V, 12V, or 15V)  <math>V_{IN}(\text{Max})</math> = Maximum Input Voltage  <math>I_{LOAD}(\text{Max})</math> = Maximum Load Current</p> <p><b>1. Inductor Selection (L1)</b></p> <p><b>A.</b> Select the correct Inductor value selection guide from <i>Figures 3, 4, 5, 6</i> (Output voltages of 3.3V, 5V, 12V or 15V respectively). For other output voltages, see the design procedure for the adjustable version.</p> <p><b>B.</b> From the inductor value selection guide, identify the inductance region intersected by <math>V_{IN}(\text{Max})</math> and <math>I_{LOAD}(\text{Max})</math>, and note the inductor code for that region.</p> <p><b>C.</b> Identify the inductor value from the inductor code, and select an appropriate inductor from the table shown in <i>Figure 9</i>. Part numbers are listed for three inductor manufacturers. The inductor chosen must be rated for operation at the LM2575 switching frequency (52 kHz) and for a current rating of <math>1.15 \times I_{LOAD}</math>. For additional inductor information, see the inductor section in the Application Hints section of this data sheet.</p> <p><b>2. Output Capacitor Selection (<math>C_{OUT}</math>)</b></p> <p><b>A.</b> The value of the output capacitor together with the inductor defines the dominate pole-pair of the switching regulator loop. For stable operation and an acceptable output ripple voltage, (approximately 1% of the output voltage) a value between 100 <math>\mu\text{F}</math> and 470 <math>\mu\text{F}</math> is recommended.</p> <p><b>B.</b> The capacitor's voltage rating should be at least 1.5 times greater than the output voltage. For a 5V regulator, a rating of at least 8V is appropriate, and a 10V or 15V rating is recommended. Higher voltage electrolytic capacitors generally have lower ESR numbers, and for this reason it may be necessary to select a capacitor rated for a higher voltage than would normally be needed.</p> <p><b>3. Catch Diode Selection (D1)</b></p> <p><b>A.</b> The catch-diode current rating must be at least 1.2 times greater than the maximum load current. Also, if the power supply design must withstand a continuous output short, the diode should have a current rating equal to the maximum current limit of the LM2575. The most stressful condition for this diode is an overload or shorted output condition.</p> <p><b>B.</b> The reverse voltage rating of the diode should be at least 1.25 times the maximum input voltage.</p> <p><b>4. Input Capacitor (<math>C_{IN}</math>)</b></p> <p>An aluminum or tantalum electrolytic bypass capacitor located close to the regulator is needed for stable operation.</p>	<p><b>Given:</b>  <math>V_{OUT} = 5\text{V}</math>  <math>V_{IN}(\text{Max}) = 20\text{V}</math>  <math>I_{LOAD}(\text{Max}) = 0.8\text{A}</math></p> <p><b>1. Inductor Selection (L1)</b></p> <p><b>A.</b> Use the selection guide shown in <i>Figure 4</i>.</p> <p><b>B.</b> From the selection guide, the inductance area intersected by the 20V line and 0.8A line is L330.</p> <p><b>C.</b> Inductor value required is 330 <math>\mu\text{H}</math>. From the table in <i>Figure 9</i>, choose AIE 415-0926, Pulse Engineering PE-52627, or RL1952.</p> <p><b>2. Output Capacitor Selection (<math>C_{OUT}</math>)</b></p> <p><b>A.</b> <math>C_{OUT} = 100 \mu\text{F}</math> to 470 <math>\mu\text{F}</math> standard aluminum electrolytic.</p> <p><b>B.</b> Capacitor voltage rating = 20V.</p> <p><b>3. Catch Diode Selection (D1)</b></p> <p><b>A.</b> For this example, a 1A current rating is adequate.</p> <p><b>B.</b> Use a 30V 1N5818 or SR103 Schottky diode, or any of the suggested fast-recovery diodes shown in <i>Figure 8</i>.</p> <p><b>4. Input Capacitor (<math>C_{IN}</math>)</b></p> <p>A 47 <math>\mu\text{F}</math>, 25V aluminum electrolytic capacitor located near the input and ground pins provides sufficient bypassing.</p>

# Inductor Value Selection Guides

(For Continuous Mode Operation)

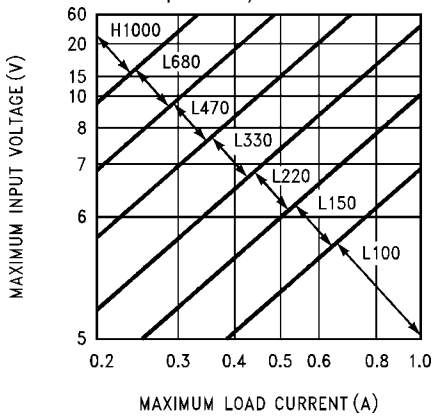

1147510

FIGURE 3. LM2575(HV)-3.3

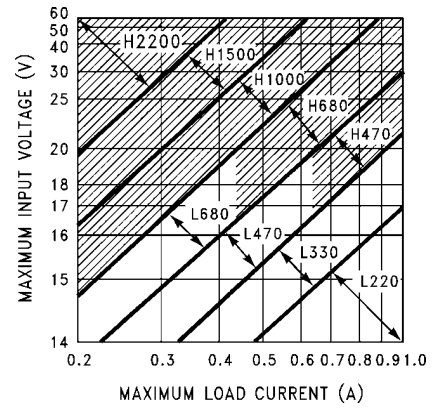

1147512

FIGURE 5. LM2575(HV)-12

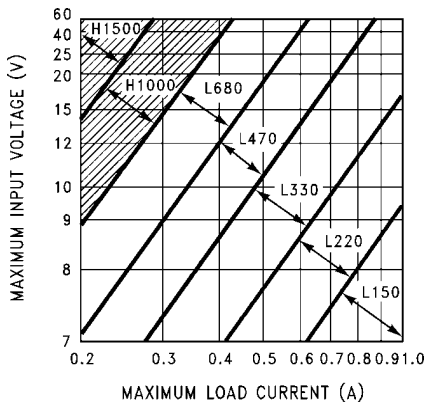

1147511

FIGURE 4. LM2575(HV)-5.0

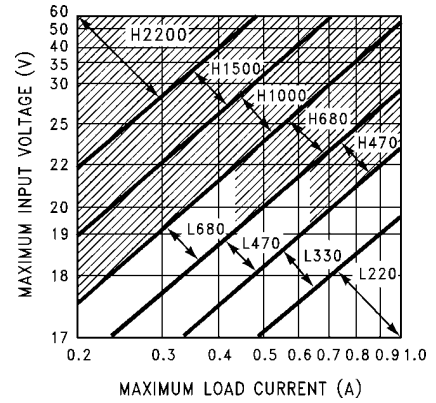

1147513

FIGURE 6. LM2575(HV)-15

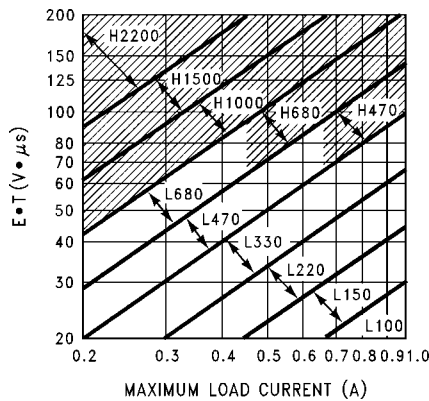

1147514

FIGURE 7. LM2575(HV)-ADJ

PROCEDURE (Adjustable Output Voltage Versions)	EXAMPLE (Adjustable Output Voltage Versions)
<p><b>Given:</b>  <math>V_{OUT}</math> = Regulated Output Voltage  <math>V_{IN}(\text{Max})</math> = Maximum Input Voltage  <math>I_{LOAD}(\text{Max})</math> = Maximum Load Current  <math>F</math> = Switching Frequency (<i>Fixed at 52 kHz</i>)</p> <p><b>1. Programming Output Voltage</b> (<i>Selecting R1 and R2, as shown in Figure 2</i>)            Use the following formula to select the appropriate resistor values.</p> $V_{OUT} = V_{REF} \left( 1 + \frac{R2}{R1} \right) \quad \text{where } V_{REF} = 1.23V$ <p><math>R_1</math> can be between 1k and 5k. (<i>For best temperature coefficient and stability with time, use 1% metal film resistors</i>)</p> $R2 = R1 \left( \frac{V_{OUT}}{V_{REF}} - 1 \right)$ <p><b>2. Inductor Selection (L1)</b>  <b>A.</b> Calculate the inductor Volt • microsecond constant, <math>E \cdot T</math> (<math>V \cdot \mu s</math>), from the following formula:</p> $E \cdot T = (V_{IN} - V_{OUT}) \frac{V_{OUT}}{V_{IN}} \cdot \frac{1000}{F \text{ (in kHz)}} (V \cdot \mu s)$ <p><b>B.</b> Use the <math>E \cdot T</math> value from the previous formula and match it with the <math>E \cdot T</math> number on the vertical axis of the <b>Inductor Value Selection Guide</b> shown in <i>Figure 7</i>.  <b>C.</b> On the horizontal axis, select the maximum load current.  <b>D.</b> Identify the inductance region intersected by the <math>E \cdot T</math> value and the maximum load current value, and note the inductor code for that region.  <b>E.</b> Identify the inductor value from the inductor code, and select an appropriate inductor from the table shown in <i>Figure 9</i>. Part numbers are listed for three inductor manufacturers. The inductor chosen must be rated for operation at the LM2575 switching frequency (52 kHz) and for a current rating of <math>1.15 \times I_{LOAD}</math>. For additional inductor information, see the inductor section in the application hints section of this data sheet.</p> <p><b>3. Output Capacitor Selection (<math>C_{OUT}</math>)</b>  <b>A.</b> The value of the output capacitor together with the inductor defines the dominate pole-pair of the switching regulator loop. For stable operation, the capacitor must satisfy the following requirement:</p> $C_{OUT} \geq 7,785 \frac{V_{IN}(\text{Max})}{V_{OUT} \cdot L(\mu H)} (\mu F)$ <p>The above formula yields capacitor values between 10 <math>\mu F</math> and 2000 <math>\mu F</math> that will satisfy the loop requirements for stable operation. But to achieve an acceptable output ripple voltage, (approximately 1% of the output voltage) and transient response, the output capacitor may need to be several times larger than the above formula yields.  <b>B.</b> The capacitor's voltage rating should be at least 1.5 times greater than the output voltage. For a 10V regulator, a rating of at least 15V or more is recommended.            Higher voltage electrolytic capacitors generally have lower ESR numbers, and for this reason it may be necessary to select a capacitor rate for a higher voltage than would normally be needed.  <i>(Continued)</i></p>	<p><b>Given:</b>  <math>V_{OUT} = 10V</math>  <math>V_{IN}(\text{Max}) = 25V</math>  <math>I_{LOAD}(\text{Max}) = 1A</math>  <math>F = 52 \text{ kHz}</math></p> <p><b>1. Programming Output Voltage</b> (<i>Selecting R1 and R2</i>)</p> $V_{OUT} = 1.23 \left( 1 + \frac{R2}{R1} \right) \quad \text{Select } R1 = 1k$ $R2 = R1 \left( \frac{V_{OUT}}{V_{REF}} - 1 \right) = 1k \left( \frac{10V}{1.23V} - 1 \right)$ <p><math>R2 = 1k (8.13 - 1) = 7.13k</math>, closest 1% value is 7.15k</p> <p><b>2. Inductor Selection (L1)</b>  <b>A.</b> Calculate <math>E \cdot T</math> (<math>V \cdot \mu s</math>)</p> $E \cdot T = (25 - 10) \cdot \frac{10}{25} \cdot \frac{1000}{52} = 115 V \cdot \mu s$ <p><b>B.</b> <math>E \cdot T = 115 V \cdot \mu s</math>  <b>C.</b> <math>I_{LOAD}(\text{Max}) = 1A</math>  <b>D.</b> Inductance Region = H470  <b>E.</b> Inductor Value = 470 <math>\mu H</math> Choose from <b>AIE</b> part #430-0634, <b>Pulse Engineering</b> part #PE-53118, or <b>Renco</b> part #RL-1961.</p> <p><b>3. Output Capacitor Selection (<math>C_{OUT}</math>)</b>  <b>A.</b></p> $C_{OUT} > 7,785 \frac{25}{10 \cdot 150} = 130 \mu F$ <p>However, for acceptable output ripple voltage select  <math>C_{OUT} \geq 220 \mu F</math>  <math>C_{OUT} = 220 \mu F</math> electrolytic capacitor</p> <p><i>(Continued)</i></p>

PROCEDURE (Adjustable Output Voltage Versions)	EXAMPLE (Adjustable Output Voltage Versions)
<p><b>4. Catch Diode Selection (D1)</b></p> <p><b>A.</b> The catch-diode current rating must be at least 1.2 times greater than the maximum load current. Also, if the power supply design must withstand a continuous output short, the diode should have a current rating equal to the maximum current limit of the LM2575. The most stressful condition for this diode is an overload or shorted output. See diode selection guide in <i>Figure 8</i>.</p> <p><b>B.</b> The reverse voltage rating of the diode should be at least 1.25 times the maximum input voltage.</p> <p><b>5. Input Capacitor (C<sub>IN</sub>)</b></p> <p>An aluminum or tantalum electrolytic bypass capacitor located close to the regulator is needed for stable operation.</p>	<p><b>4. Catch Diode Selection (D1)</b></p> <p><b>A.</b> For this example, a 3A current rating is adequate.</p> <p><b>B.</b> Use a 40V MBR340 or 31DQ04 Schottky diode, or any of the suggested fast-recovery diodes in <i>Figure 8</i>.</p> <p><b>5. Input Capacitor (C<sub>IN</sub>)</b></p> <p>A 100 <math>\mu</math>F aluminum electrolytic capacitor located near the input and ground pins provides sufficient bypassing.</p>

*To further simplify the buck regulator design procedure, National Semiconductor is making available computer design software to be used with the Simple Switcher line of switching regulators. **Switchers Made Simple** (version 3.3) is available on a (3½ ) diskette for IBM compatible computers from a National Semiconductor sales office in your area.*



$V_R$	Schottky		Fast Recovery	
	1A	3A	1A	3A
20V	1N5817 MBR120P SR102	1N5820 MBR320 SR302	The following diodes are all rated to 100V  11DF1 MUR110 HER102	The following diodes are all rated to 100V  31DF1 MURD310 HER302
30V	1N5818 MBR130P 11DQ03 SR103	1N5821 MBR330 31DQ03 SR303		
40V	1N5819 MBR140P 11DQ04 SR104	1N5822 MBR340 31DQ04 SR304		
50V	MBR150 11DQ05 SR105	MBR350 31DQ05 SR305		
60V	MBR160 11DQ06 SR106	MBR360 31DQ06 SR306		

FIGURE 8. Diode Selection Guide

Inductor Code	Inductor Value	Schott (Note 15)	Pulse Eng. (Note 16)	Renco (Note 17)
L100	100 $\mu$ H	67127000	PE-92108	RL2444
L150	150 $\mu$ H	67127010	PE-53113	RL1954
L220	220 $\mu$ H	67127020	PE-52626	RL1953
L330	330 $\mu$ H	67127030	PE-52627	RL1952
L470	470 $\mu$ H	67127040	PE-53114	RL1951
L680	680 $\mu$ H	67127050	PE-52629	RL1950
H150	150 $\mu$ H	67127060	PE-53115	RL2445
H220	220 $\mu$ H	67127070	PE-53116	RL2446
H330	330 $\mu$ H	67127080	PE-53117	RL2447
H470	470 $\mu$ H	67127090	PE-53118	RL1961
H680	680 $\mu$ H	67127100	PE-53119	RL1960
H1000	1000 $\mu$ H	67127110	PE-53120	RL1959
H1500	1500 $\mu$ H	67127120	PE-53121	RL1958
H2200	2200 $\mu$ H	67127130	PE-53122	RL2448

**Note 15:** Schott Corp., (612) 475-1173, 1000 Parkers Lake Rd., Wayzata, MN 55391.

**Note 16:** Pulse Engineering, (619) 674-8100, P.O. Box 12236, San Diego, CA 92112.

**Note 17:** Renco Electronics Inc., (516) 586-5566, 60 Jeffryn Blvd. East, Deer Park, NY 11729.

FIGURE 9. Inductor Selection by Manufacturer's Part Number

## Application Hints

### INPUT CAPACITOR ( $C_{IN}$ )

To maintain stability, the regulator input pin must be bypassed with at least a 47  $\mu$ F electrolytic capacitor. The capacitor's leads must be kept short, and located near the regulator.

If the operating temperature range includes temperatures below  $-25^{\circ}\text{C}$ , the input capacitor value may need to be larger. With most electrolytic capacitors, the capacitance value decreases and the ESR increases with lower temperatures and age. Paralleling a ceramic or solid tantalum capacitor will increase the regulator stability at cold temperatures. For maximum capacitor operating lifetime, the capacitor's RMS ripple current rating should be greater than

$$1.2 \times \left( \frac{t_{ON}}{T} \right) \times I_{LOAD}$$

$$\text{where } \frac{t_{ON}}{T} = \frac{V_{OUT}}{V_{IN}} \text{ for a buck regulator}$$

$$\text{and } \frac{t_{ON}}{T} = \frac{|V_{OUT}|}{|V_{OUT}| + V_{IN}} \text{ for a buck-boost regulator.}$$

### INDUCTOR SELECTION

All switching regulators have two basic modes of operation: continuous and discontinuous. The difference between the two types relates to the inductor current, whether it is flowing continuously, or if it drops to zero for a period of time in the normal switching cycle. Each mode has distinctively different operating characteristics, which can affect the regulator performance and requirements.

The LM2575 (or any of the Simple Switcher family) can be used for both continuous and discontinuous modes of operation.

The inductor value selection guides in *Figure 3* through *Figure 7* were designed for buck regulator designs of the continuous inductor current type. When using inductor values shown in the inductor selection guide, the peak-to-peak inductor ripple current will be approximately 20% to 30% of the maximum DC current. With relatively heavy load currents, the circuit operates in the continuous mode (inductor current always flowing), but under light load conditions, the circuit will be forced to the discontinuous mode (inductor current falls to zero for a period of time). This discontinuous mode of operation is perfectly acceptable. For light loads (less than approximately 200 mA) it may be desirable to operate the regulator in the discontinuous mode, primarily because of the lower inductor values required for the discontinuous mode.

The selection guide chooses inductor values suitable for continuous mode operation, but if the inductor value chosen is prohibitively high, the designer should investigate the possibility of discontinuous operation. The computer design software **Switchers Made Simple** will provide all component values for discontinuous (as well as continuous) mode of operation.

Inductors are available in different styles such as pot core, toroid, E-frame, bobbin core, etc., as well as different core materials, such as ferrites and powdered iron. The least expensive, the bobbin core type, consists of wire wrapped on a ferrite rod core. This type of construction makes for an inexpensive inductor, but since the magnetic flux is not completely contained within the core, it generates more electromagnetic interference (EMI). This EMI can cause problems in sensitive

circuits, or can give incorrect scope readings because of induced voltages in the scope probe.

The inductors listed in the selection chart include ferrite pot core construction for AIE, powdered iron toroid for Pulse Engineering, and ferrite bobbin core for Renco.

An inductor should not be operated beyond its maximum rated current because it may saturate. When an inductor begins to saturate, the inductance decreases rapidly and the inductor begins to look mainly resistive (the DC resistance of the winding). This will cause the switch current to rise very rapidly. Different inductor types have different saturation characteristics, and this should be kept in mind when selecting an inductor.

The inductor manufacturer's data sheets include current and energy limits to avoid inductor saturation.

### INDUCTOR RIPPLE CURRENT

When the switcher is operating in the continuous mode, the inductor current waveform ranges from a triangular to a sawtooth type of waveform (depending on the input voltage). For a given input voltage and output voltage, the peak-to-peak amplitude of this inductor current waveform remains constant. As the load current rises or falls, the entire sawtooth current waveform also rises or falls. The average DC value of this waveform is equal to the DC load current (in the buck regulator configuration).

If the load current drops to a low enough level, the bottom of the sawtooth current waveform will reach zero, and the switcher will change to a discontinuous mode of operation. This is a perfectly acceptable mode of operation. Any buck switching regulator (no matter how large the inductor value is) will be forced to run discontinuous if the load current is light enough.

### OUTPUT CAPACITOR

An output capacitor is required to filter the output voltage and is needed for loop stability. The capacitor should be located near the LM2575 using short pc board traces. Standard aluminum electrolytics are usually adequate, but low ESR types are recommended for low output ripple voltage and good stability. The ESR of a capacitor depends on many factors, some which are: the value, the voltage rating, physical size and the type of construction. In general, low value or low voltage (less than 12V) electrolytic capacitors usually have higher ESR numbers.

The amount of output ripple voltage is primarily a function of the ESR (Equivalent Series Resistance) of the output capacitor and the amplitude of the inductor ripple current ( $\Delta I_{IND}$ ). See the section on inductor ripple current in Application Hints. The lower capacitor values (220  $\mu$ F–680  $\mu$ F) will allow typically 50 mV to 150 mV of output ripple voltage, while larger-value capacitors will reduce the ripple to approximately 20 mV to 50 mV.

$$\text{Output Ripple Voltage} = (\Delta I_{IND}) (\text{ESR of } C_{OUT})$$

To further reduce the output ripple voltage, several standard electrolytic capacitors may be paralleled, or a higher-grade capacitor may be used. Such capacitors are often called "high-frequency," "low-inductance," or "low-ESR." These will reduce the output ripple to 10 mV or 20 mV. However, when operating in the continuous mode, reducing the ESR below  $0.05\Omega$  can cause instability in the regulator.

Tantalum capacitors can have a very low ESR, and should be carefully evaluated if it is the only output capacitor. Because of their good low temperature characteristics, a tantalum can

be used in parallel with aluminum electrolytics, with the tantalum making up 10% or 20% of the total capacitance.

The capacitor's ripple current rating at 52 kHz should be at least 50% higher than the peak-to-peak inductor ripple current.

### CATCH DIODE

Buck regulators require a diode to provide a return path for the inductor current when the switch is off. This diode should be located close to the LM2575 using short leads and short printed circuit traces.

Because of their fast switching speed and low forward voltage drop, Schottky diodes provide the best efficiency, especially in low output voltage switching regulators (less than 5V). Fast-Recovery, High-Efficiency, or Ultra-Fast Recovery diodes are also suitable, but some types with an abrupt turn-off characteristic may cause instability and EMI problems. A fast-recovery diode with soft recovery characteristics is a better choice. Standard 60 Hz diodes (e.g., 1N4001 or 1N5400, etc.) are also **not suitable**. See *Figure 8* for Schottky and "soft" fast-recovery diode selection guide.

### OUTPUT VOLTAGE RIPPLE AND TRANSIENTS

The output voltage of a switching power supply will contain a sawtooth ripple voltage at the switcher frequency, typically about 1% of the output voltage, and may also contain short voltage spikes at the peaks of the sawtooth waveform.

The output ripple voltage is due mainly to the inductor sawtooth ripple current multiplied by the ESR of the output capacitor. (See the inductor selection in the application hints.)

The voltage spikes are present because of the fast switching action of the output switch, and the parasitic inductance of the output filter capacitor. To minimize these voltage spikes, special low inductance capacitors can be used, and their lead lengths must be kept short. Wiring inductance, stray capacitance, as well as the scope probe used to evaluate these transients, all contribute to the amplitude of these spikes.

An additional small LC filter (20  $\mu$ H & 100  $\mu$ F) can be added to the output (as shown in *Figure 15*) to further reduce the amount of output ripple and transients. A 10  $\times$  reduction in output ripple voltage and transients is possible with this filter.

### FEEDBACK CONNECTION

The LM2575 (fixed voltage versions) feedback pin must be wired to the output voltage point of the switching power supply. When using the adjustable version, physically locate both output voltage programming resistors near the LM2575 to avoid picking up unwanted noise. Avoid using resistors greater than 100 k $\Omega$  because of the increased chance of noise pickup.

### $\overline{\text{ON}}$ /OFF INPUT

For normal operation, the  $\overline{\text{ON}}$  /OFF pin should be grounded or driven with a low-level TTL voltage (typically below 1.6V). To put the regulator into standby mode, drive this pin with a high-level TTL or CMOS signal. The  $\overline{\text{ON}}$  /OFF pin can be safely pulled up to  $+V_{\text{IN}}$  without a resistor in series with it. The  $\overline{\text{ON}}$  /OFF pin should not be left open.

### GROUNDING

To maintain output voltage stability, the power ground connections must be low-impedance (see *Figure 2*). For the TO-3 style package, the case is ground. For the 5-lead TO-220 style package, both the tab and pin 3 are ground and either connection may be used, as they are both part of the same copper lead frame.

With the N or M packages, all the pins labeled ground, power ground, or signal ground should be soldered directly to wide printed circuit board copper traces. This assures both low inductance connections and good thermal properties.

### HEAT SINK/THERMAL CONSIDERATIONS

In many cases, no heat sink is required to keep the LM2575 junction temperature within the allowed operating range. For each application, to determine whether or not a heat sink will be required, the following must be identified:

1. Maximum ambient temperature (in the application).
2. Maximum regulator power dissipation (in application).
3. Maximum allowed junction temperature (150°C for the LM1575 or 125°C for the LM2575). For a safe, conservative design, a temperature approximately 15°C cooler than the maximum temperature should be selected.
4. LM2575 package thermal resistances  $\theta_{\text{JA}}$  and  $\theta_{\text{JC}}$ .

Total power dissipated by the LM2575 can be estimated as follows:

$$P_D = (V_{\text{IN}}) (I_Q) + (V_O/V_{\text{IN}}) (I_{\text{LOAD}}) (V_{\text{SAT}})$$

where  $I_Q$  (quiescent current) and  $V_{\text{SAT}}$  can be found in the Characteristic Curves shown previously,  $V_{\text{IN}}$  is the applied minimum input voltage,  $V_O$  is the regulated output voltage, and  $I_{\text{LOAD}}$  is the load current. The dynamic losses during turn-on and turn-off are negligible if a Schottky type catch diode is used.

When no heat sink is used, the junction temperature rise can be determined by the following:

$$\Delta T_J = (P_D) (\theta_{\text{JA}})$$

To arrive at the actual operating junction temperature, add the junction temperature rise to the maximum ambient temperature.

$$T_J = \Delta T_J + T_A$$

If the actual operating junction temperature is greater than the selected safe operating junction temperature determined in step 3, then a heat sink is required.

When using a heat sink, the junction temperature rise can be determined by the following:

$$\Delta T_J = (P_D) (\theta_{\text{JC}} + \theta_{\text{interface}} + \theta_{\text{Heat sink}})$$

The operating junction temperature will be:

$$T_J = T_A + \Delta T_J$$

As above, if the actual operating junction temperature is greater than the selected safe operating junction temperature, then a larger heat sink is required (one that has a lower thermal resistance).

When using the LM2575 in the plastic DIP (N) or surface mount (M) packages, several items about the thermal properties of the packages should be understood. The majority of the heat is conducted out of the package through the leads, with a minor portion through the plastic parts of the package. Since the lead frame is solid copper, heat from the die is readily conducted through the leads to the printed circuit board copper, which is acting as a heat sink.

For best thermal performance, the ground pins and all the unconnected pins should be soldered to generous amounts of printed circuit board copper, such as a ground plane. Large areas of copper provide the best transfer of heat to the surrounding air. Copper on both sides of the board is also helpful in getting the heat away from the package, even if there is no direct copper contact between the two sides. Thermal resis-

tance numbers as low as 40°C/W for the SO package, and 30°C/W for the N package can be realized with a carefully engineered pc board.

Included on the **Switchers Made Simple** design software is a more precise (non-linear) thermal model that can be used to determine junction temperature with different input-output parameters or different component values. It can also calculate the heat sink thermal resistance required to maintain the regulators junction temperature below the maximum operating temperature.

## Additional Applications

### INVERTING REGULATOR

Figure 10 shows a LM2575-12 in a buck-boost configuration to generate a negative 12V output from a positive input voltage. This circuit bootstraps the regulator's ground pin to the negative output voltage, then by grounding the feedback pin, the regulator senses the inverted output voltage and regulates it to -12V.

For an input voltage of 12V or more, the maximum available output current in this configuration is approximately 0.35A. At lighter loads, the minimum input voltage required drops to approximately 4.7V.

The switch currents in this buck-boost configuration are higher than in the standard buck-mode design, thus lowering the available output current. Also, the start-up input current of the buck-boost converter is higher than the standard buck-mode regulator, and this may overload an input power source with a current limit less than 1.5A. Using a delayed turn-on or an undervoltage lockout circuit (described in the next section)

would allow the input voltage to rise to a high enough level before the switcher would be allowed to turn on.

Because of the structural differences between the buck and the buck-boost regulator topologies, the buck regulator design procedure section can not be used to select the inductor or the output capacitor. The recommended range of inductor values for the buck-boost design is between 68  $\mu\text{H}$  and 220  $\mu\text{H}$ , and the output capacitor values must be larger than what is normally required for buck designs. Low input voltages or high output currents require a large value output capacitor (in the thousands of micro Farads).

The peak inductor current, which is the same as the peak switch current, can be calculated from the following formula:

$$I_p \approx \frac{I_{\text{LOAD}}(V_{\text{IN}} + |V_{\text{O}}|)}{V_{\text{IN}}} + \frac{V_{\text{IN}}|V_{\text{O}}|}{V_{\text{IN}} + |V_{\text{O}}|} \times \frac{1}{2 L_1 f_{\text{osc}}}$$

Where  $f_{\text{osc}} = 52 \text{ kHz}$ . Under normal continuous inductor current operating conditions, the minimum  $V_{\text{IN}}$  represents the worst case. Select an inductor that is rated for the peak current anticipated.

Also, the maximum voltage appearing across the regulator is the absolute sum of the input and output voltage. For a -12V output, the maximum input voltage for the LM2575 is +28V, or +48V for the LM2575HV.

The **Switchers Made Simple** (version 3.3) design software can be used to determine the feasibility of regulator designs using different topologies, different input-output parameters, different components, etc.

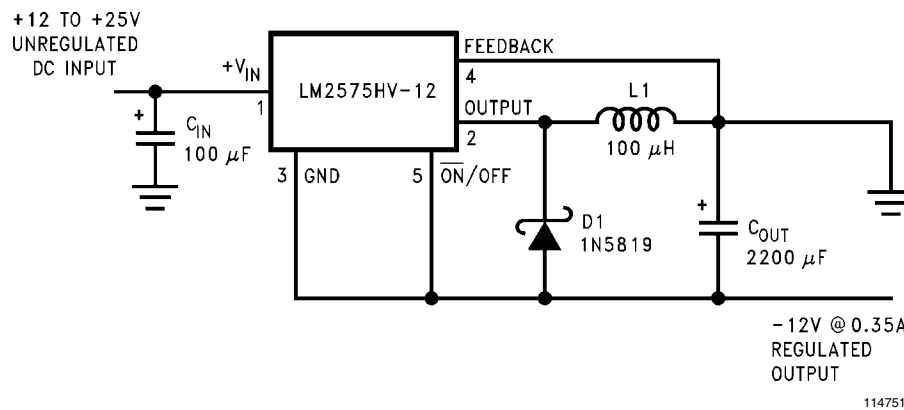
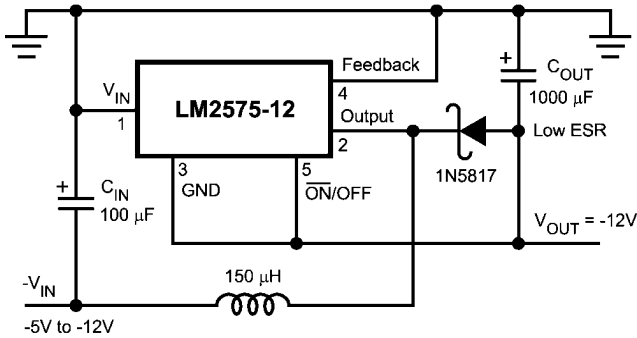

FIGURE 10. Inverting Buck-Boost Develops -12V

### NEGATIVE BOOST REGULATOR

Another variation on the buck-boost topology is the negative boost configuration. The circuit in *Figure 11* accepts an input voltage ranging from  $-5\text{V}$  to  $-12\text{V}$  and provides a regulated  $-12\text{V}$  output. Input voltages greater than  $-12\text{V}$  will cause the output to rise above  $-12\text{V}$ , but will not damage the regulator. Because of the boosting function of this type of regulator, the switch current is relatively high, especially at low input voltages. Output load current limitations are a result of the maximum current rating of the switch. Also, boost regulators can not provide current limiting load protection in the event of a shorted load, so some other means (such as a fuse) may be necessary.



1147516

Typical Load Current  
 200 mA for  $V_{IN} = -5.2\text{V}$   
 500 mA for  $V_{IN} = -7\text{V}$

Note: Pin numbers are for TO-220 package.

FIGURE 11. Negative Boost

### UNDERVOLTAGE LOCKOUT

In some applications it is desirable to keep the regulator off until the input voltage reaches a certain threshold. An undervoltage lockout circuit which accomplishes this task is shown in *Figure 12*, while *Figure 13* shows the same circuit applied to a buck-boost configuration. These circuits keep the regulator off until the input voltage reaches a predetermined level.

$$V_{TH} = V_{Z1} + 2V_{BE}(Q1)$$

### DELAYED STARTUP

The  $\overline{\text{ON}}/\text{OFF}$  pin can be used to provide a delayed startup feature as shown in *Figure 14*. With an input voltage of  $20\text{V}$  and for the part values shown, the circuit provides approximately  $10\text{ms}$  of delay time before the circuit begins switching. Increasing the RC time constant can provide longer delay times. But excessively large RC time constants can cause problems with input voltages that are high in  $60\text{Hz}$  or  $120\text{Hz}$  ripple, by coupling the ripple into the  $\overline{\text{ON}}/\text{OFF}$  pin.

### ADJUSTABLE OUTPUT, LOW-RIPPLE POWER SUPPLY

A  $1\text{A}$  power supply that features an adjustable output voltage is shown in *Figure 15*. An additional L-C filter that reduces the output ripple by a factor of 10 or more is included in this circuit.

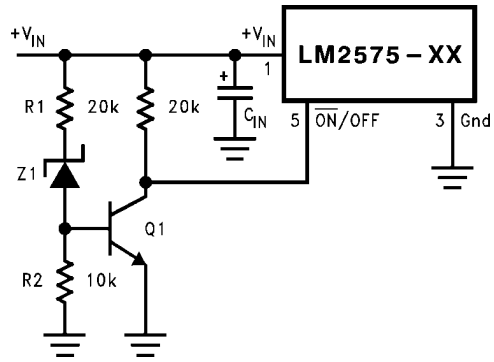

1147517

Note: Complete circuit not shown.

Note: Pin numbers are for the TO-220 package.

FIGURE 12. Undervoltage Lockout for Buck Circuit

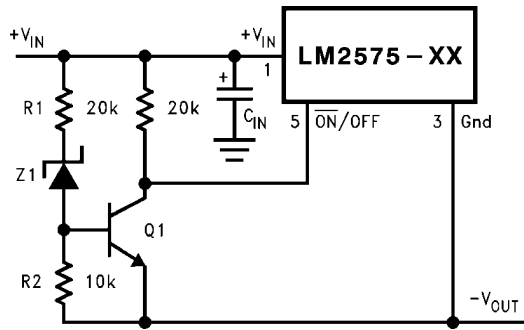

1147518

Note: Complete circuit not shown (see *Figure 10*).

Note: Pin numbers are for the TO-220 package.

FIGURE 13. Undervoltage Lockout for Buck-Boost Circuit

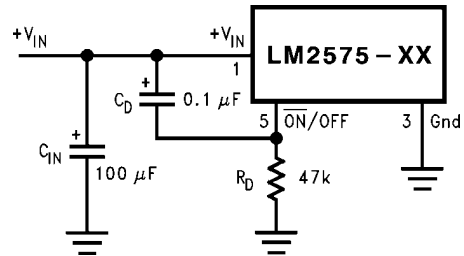

1147519

Note: Complete circuit not shown.

Note: Pin numbers are for the TO-220 package.

FIGURE 14. Delayed Startup

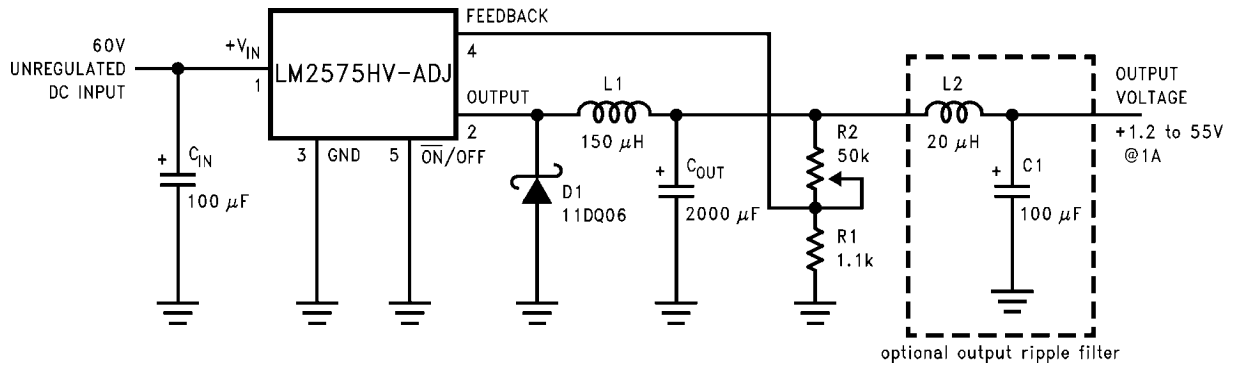

Note: Pin numbers are for the TO-220 package.

1147520

FIGURE 15. 1.2V to 55V Adjustable 1A Power Supply with Low Output Ripple

## Definition of Terms

### BUCK REGULATOR

A switching regulator topology in which a higher voltage is converted to a lower voltage. Also known as a step-down switching regulator.

### BUCK-BOOST REGULATOR

A switching regulator topology in which a positive voltage is converted to a negative voltage without a transformer.

### DUTY CYCLE (D)

Ratio of the output switch's on-time to the oscillator period.

$$\text{for buck regulator} \quad D = \frac{t_{\text{ON}}}{T} = \frac{V_{\text{OUT}}}{V_{\text{IN}}}$$

$$\text{for buck-boost regulator} \quad D = \frac{t_{\text{ON}}}{T} = \frac{|V_{\text{O}}|}{|V_{\text{O}}| + V_{\text{IN}}}$$

### CATCH DIODE OR CURRENT STEERING DIODE

The diode which provides a return path for the load current when the LM2575 switch is OFF.

### EFFICIENCY ( $\eta$ )

The proportion of input power actually delivered to the load.

$$\eta = \frac{P_{\text{OUT}}}{P_{\text{IN}}} = \frac{P_{\text{OUT}}}{P_{\text{OUT}} + P_{\text{LOSS}}}$$

### CAPACITOR EQUIVALENT SERIES RESISTANCE (ESR)

The purely resistive component of a real capacitor's impedance (see *Figure 16*). It causes power loss resulting in capacitor heating, which directly affects the capacitor's operating lifetime. When used as a switching regulator output filter, higher ESR values result in higher output ripple voltages.

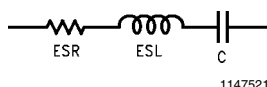

FIGURE 16. Simple Model of a Real Capacitor

Most standard aluminum electrolytic capacitors in the 100  $\mu\text{F}$ –1000  $\mu\text{F}$  range have 0.5 $\Omega$  to 0.1 $\Omega$  ESR. Higher-grade capacitors (“low-ESR”, “high-frequency”, or “low-inductance”) in the 100  $\mu\text{F}$ –1000  $\mu\text{F}$  range generally have ESR of less than 0.15 $\Omega$ .

### EQUIVALENT SERIES INDUCTANCE (ESL)

The pure inductance component of a capacitor (see *Figure 16*). The amount of inductance is determined to a large extent on the capacitor's construction. In a buck regulator, this unwanted inductance causes voltage spikes to appear on the output.

### OUTPUT RIPPLE VOLTAGE

The AC component of the switching regulator's output voltage. It is usually dominated by the output capacitor's ESR multiplied by the inductor's ripple current ( $\Delta I_{\text{IND}}$ ). The peak-to-peak value of this sawtooth ripple current can be determined by reading the Inductor Ripple Current section of the Application hints.

### CAPACITOR RIPPLE CURRENT

RMS value of the maximum allowable alternating current at which a capacitor can be operated continuously at a specified temperature.

### STANDBY QUIESCENT CURRENT ( $I_{\text{STBY}}$ )

Supply current required by the LM2575 when in the standby mode (ON/OFF pin is driven to TTL-high voltage, thus turning the output switch OFF).

### INDUCTOR RIPPLE CURRENT ( $\Delta I_{\text{IND}}$ )

The peak-to-peak value of the inductor current waveform, typically a sawtooth waveform when the regulator is operating in the continuous mode (vs. discontinuous mode).

### CONTINUOUS/DISCONTINUOUS MODE OPERATION

Relates to the inductor current. In the continuous mode, the inductor current is always flowing and never drops to zero, vs. the discontinuous mode, where the inductor current drops to zero for a period of time in the normal switching cycle.

### INDUCTOR SATURATION

The condition which exists when an inductor cannot hold any more magnetic flux. When an inductor saturates, the inductor appears less inductive and the resistive component dominates. Inductor current is then limited only by the DC resistance of the wire and the available source current.

### OPERATING VOLT MICROSECOND CONSTANT ( $E \cdot T_{\text{op}}$ )

The product (in Volt $\cdot\mu\text{s}$ ) of the voltage applied to the inductor and the time the voltage is applied. This  $E \cdot T_{\text{op}}$  constant is a measure of the energy handling capability of an inductor and is dependent upon the type of core, the core area, the number of turns, and the duty cycle.

## Physical Dimensions inches (millimeters) unless otherwise noted

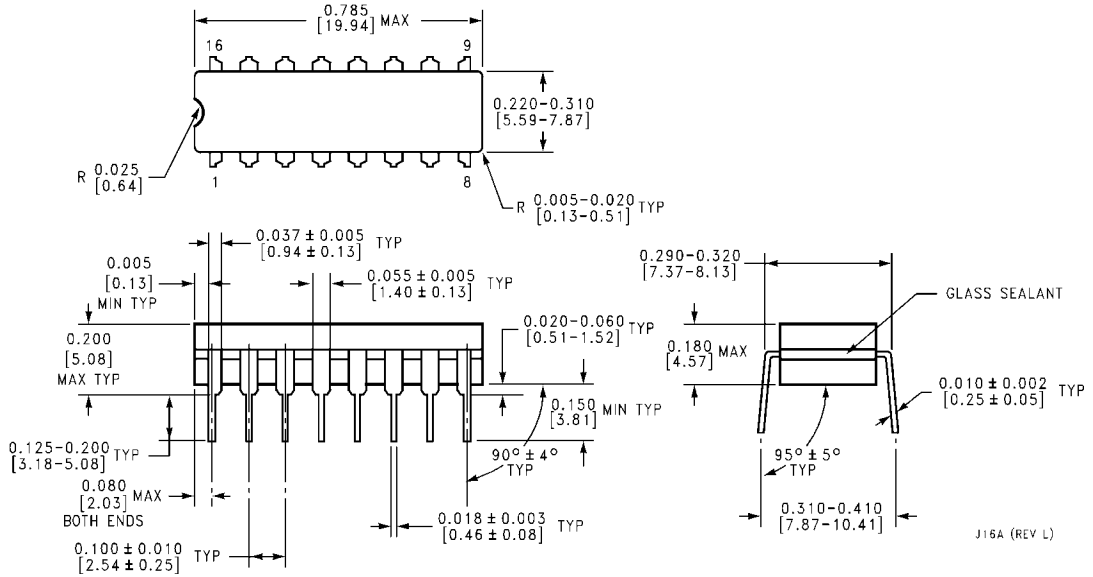

**16-Lead Ceramic Dual-in-Line (J)**  
**Order Number LM1575J-3.3/883, LM1575J-5.0/883,**  
**LM1575J-12/883, LM1575J-15/883, or LM1575J-ADJ/883**  
**NS Package Number J16A**

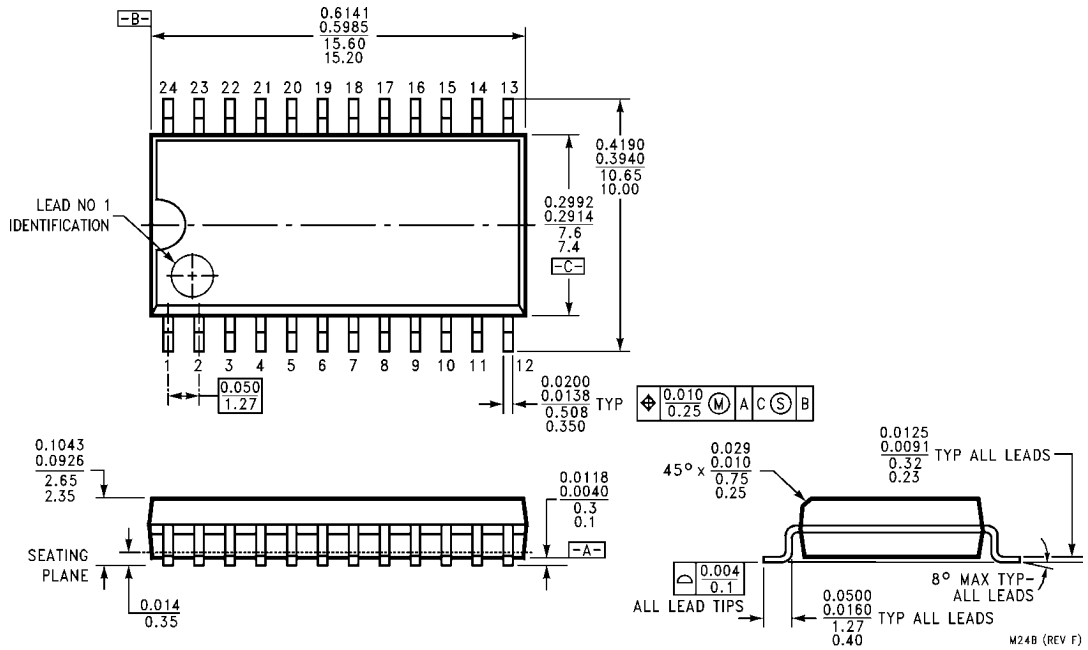

**24-Lead Wide Surface Mount (WM)**  
**Order Number LM2575M-5.0, LM2575HVM-5.0, LM2575M-12,**  
**LM2575HVM-12, LM2575M-15, LM2575HVM-15,**  
**LM2575M-ADJ or LM2575HVM-ADJ**  
**NS Package Number M24B**



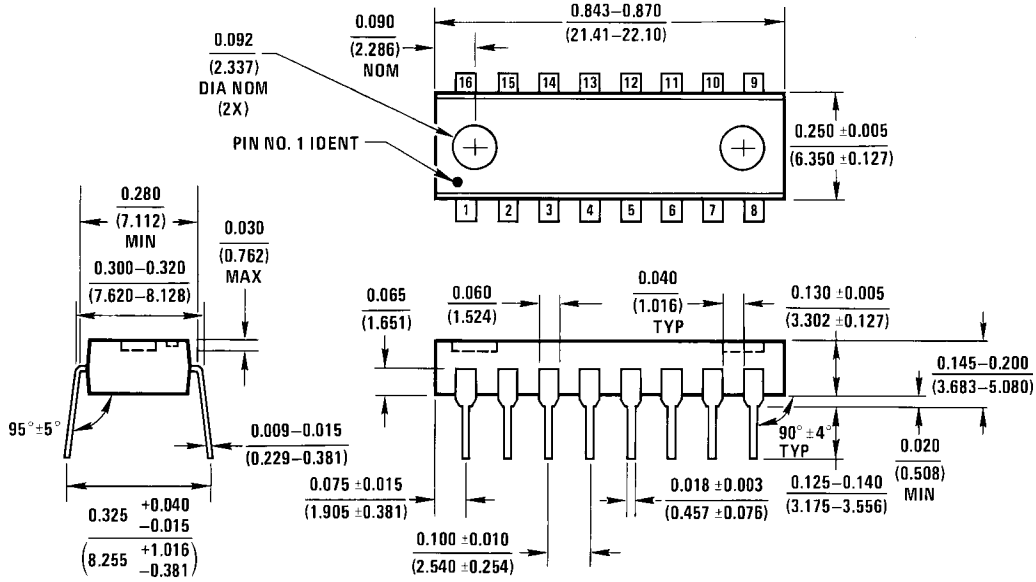

N16A (REV E)

**16-Lead Molded DIP (N)**  
**Order Number LM2575N-5.0, LM2575HVN-5.0, LM2575N-12, LM2575HVN-12,**  
**LM2575N-15, LM2575HVN-15, LM2575N-ADJ or LM2575HVN-ADJ**  
**NS Package Number N16A**

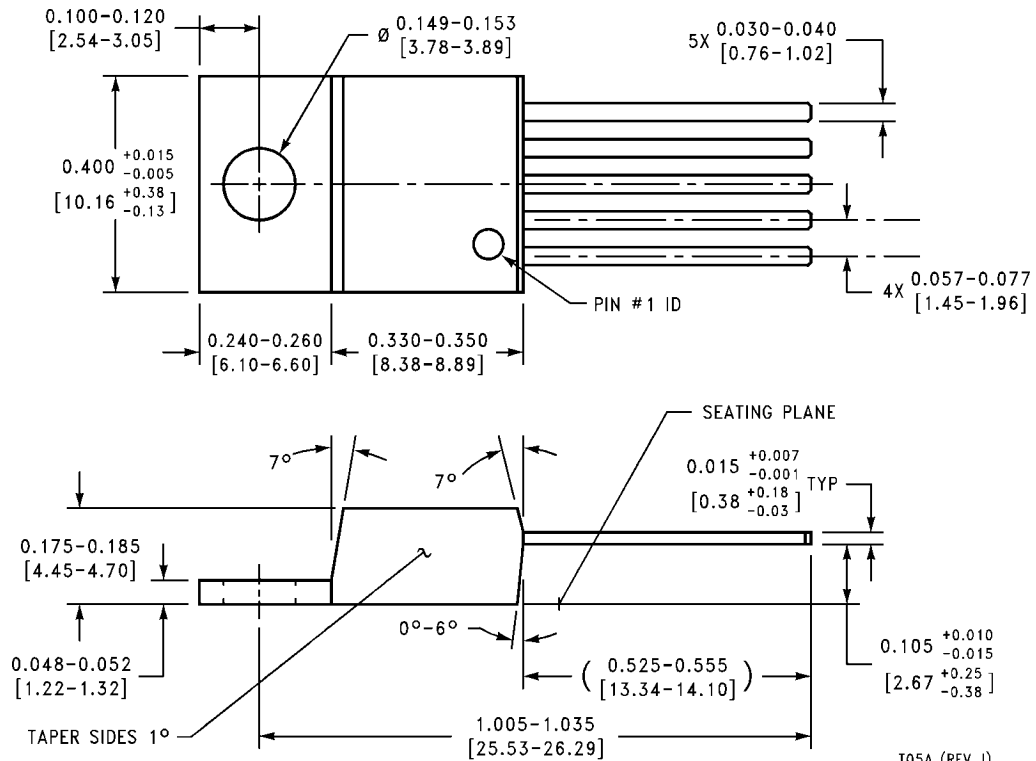

T05A (REV J)

**5-Lead TO-220 (T)**  
**Order Number LM2575T-3.3, LM2575HVT-3.3, LM2575T-5.0, LM2575HVT-5.0, LM2575T-12,**  
**LM2575HVT-12, LM2575T-15, LM2575HVT-15, LM2575T-ADJ or LM2575HVT-ADJ**  
**NS Package Number T05A**

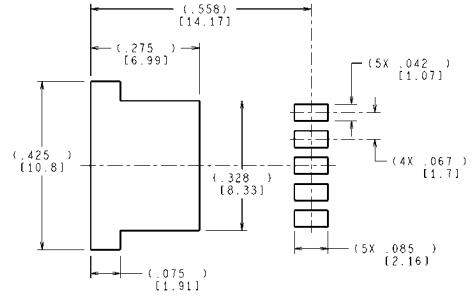
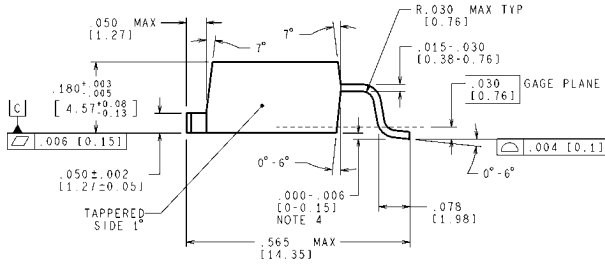
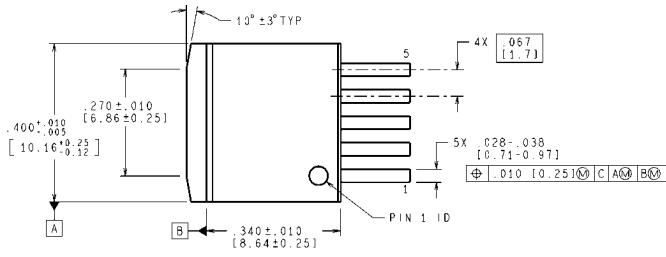

LAND PATTERN RECOMMENDATION

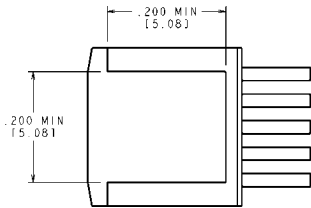

CONTROLLING DIMENSION IS INCH  
VALUES IN [ ] ARE MILLIMETERS  
DIMENSIONS IN ( ) FOR REFERENCE ONLY

TSSB (Rev D)

**TO-263, Molded, 5-Lead Surface Mount**  
**Order Number LM2575S-3.3, LM2575HVS-3.3, LM2575S-5.0, LM2575HVS-5.0, LM2575S-12,**  
**LM2575HVS-12, LM2575S-15, LM2575HVS-15, LM2575S-ADJ or LM2575HVS-ADJ**  
**NS Package Number TS5B**

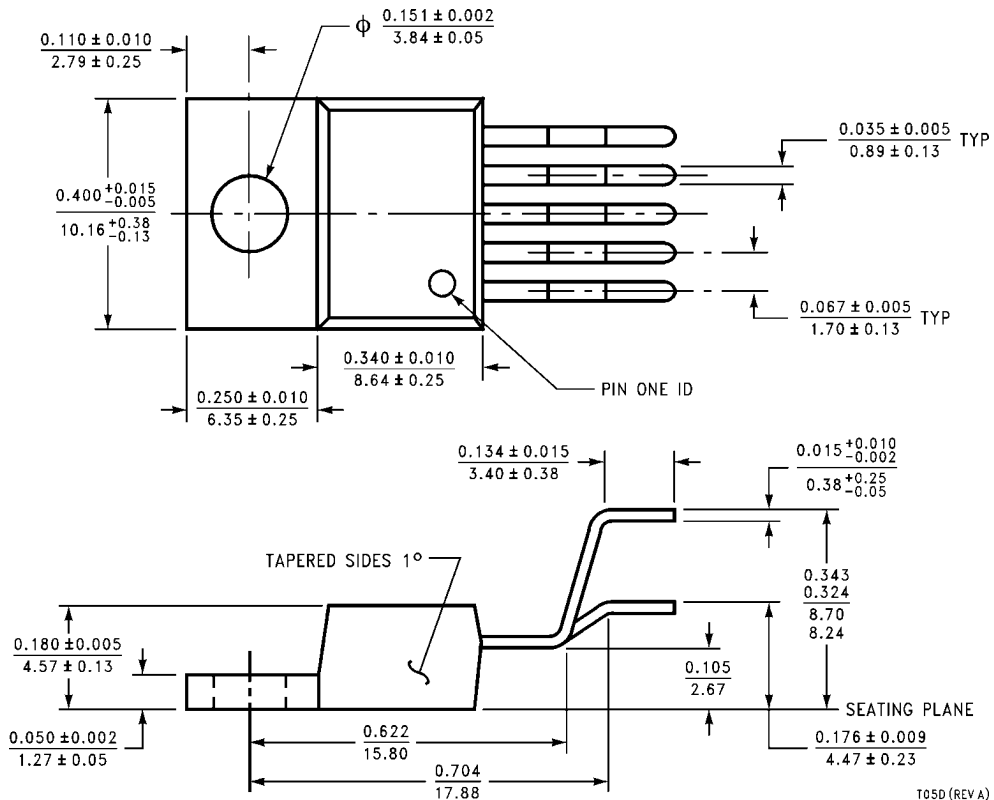

T05D (REV A)

**Bent, Staggered 5-Lead TO-220 (T)**  
**Order Number LM2575T-3.3 Flow LB03, LM2575HVT-3.3 Flow LB03,**  
**LM2575T-5.0 Flow LB03, LM2575HVT-5.0 Flow LB03,**  
**LM2575T-12 Flow LB03, LM2575HVT-12 Flow LB03,**  
**LM2575T-15 Flow LB03, LM2575HVT-15 Flow LB03,**  
**LM2575T-ADJ Flow LB03 or LM2575HVT-ADJ Flow LB03**  
**NS Package Number T05D**

## Notes

THE CONTENTS OF THIS DOCUMENT ARE PROVIDED IN CONNECTION WITH NATIONAL SEMICONDUCTOR CORPORATION ("NATIONAL") PRODUCTS. NATIONAL MAKES NO REPRESENTATIONS OR WARRANTIES WITH RESPECT TO THE ACCURACY OR COMPLETENESS OF THE CONTENTS OF THIS PUBLICATION AND RESERVES THE RIGHT TO MAKE CHANGES TO SPECIFICATIONS AND PRODUCT DESCRIPTIONS AT ANY TIME WITHOUT NOTICE. NO LICENSE, WHETHER EXPRESS, IMPLIED, ARISING BY ESTOPPEL OR OTHERWISE, TO ANY INTELLECTUAL PROPERTY RIGHTS IS GRANTED BY THIS DOCUMENT.

TESTING AND OTHER QUALITY CONTROLS ARE USED TO THE EXTENT NATIONAL DEEMS NECESSARY TO SUPPORT NATIONAL'S PRODUCT WARRANTY. EXCEPT WHERE MANDATED BY GOVERNMENT REQUIREMENTS, TESTING OF ALL PARAMETERS OF EACH PRODUCT IS NOT NECESSARILY PERFORMED. NATIONAL ASSUMES NO LIABILITY FOR APPLICATIONS ASSISTANCE OR BUYER PRODUCT DESIGN. BUYERS ARE RESPONSIBLE FOR THEIR PRODUCTS AND APPLICATIONS USING NATIONAL COMPONENTS. PRIOR TO USING OR DISTRIBUTING ANY PRODUCTS THAT INCLUDE NATIONAL COMPONENTS, BUYERS SHOULD PROVIDE ADEQUATE DESIGN, TESTING AND OPERATING SAFEGUARDS.

EXCEPT AS PROVIDED IN NATIONAL'S TERMS AND CONDITIONS OF SALE FOR SUCH PRODUCTS, NATIONAL ASSUMES NO LIABILITY WHATSOEVER, AND NATIONAL DISCLAIMS ANY EXPRESS OR IMPLIED WARRANTY RELATING TO THE SALE AND/OR USE OF NATIONAL PRODUCTS INCLUDING LIABILITY OR WARRANTIES RELATING TO FITNESS FOR A PARTICULAR PURPOSE, MERCHANTABILITY, OR INFRINGEMENT OF ANY PATENT, COPYRIGHT OR OTHER INTELLECTUAL PROPERTY RIGHT.

### LIFE SUPPORT POLICY

**NATIONAL'S PRODUCTS ARE NOT AUTHORIZED FOR USE AS CRITICAL COMPONENTS IN LIFE SUPPORT DEVICES OR SYSTEMS WITHOUT THE EXPRESS PRIOR WRITTEN APPROVAL OF THE CHIEF EXECUTIVE OFFICER AND GENERAL COUNSEL OF NATIONAL SEMICONDUCTOR CORPORATION.** As used herein:

Life support devices or systems are devices which (a) are intended for surgical implant into the body, or (b) support or sustain life and whose failure to perform when properly used in accordance with instructions for use provided in the labeling can be reasonably expected to result in a significant injury to the user. A critical component is any component in a life support device or system whose failure to perform can be reasonably expected to cause the failure of the life support device or system or to affect its safety or effectiveness.

National Semiconductor and the National Semiconductor logo are registered trademarks of National Semiconductor Corporation. All other brand or product names may be trademarks or registered trademarks of their respective holders.

Copyright© 2007 National Semiconductor Corporation

For the most current product information visit us at [www.national.com](http://www.national.com)



**National Semiconductor Americas Customer Support Center**  
 Email: [new.feedback@nsc.com](mailto:new.feedback@nsc.com)  
 Tel: 1-800-272-9959

**National Semiconductor Europe Customer Support Center**  
 Fax: +49 (0) 180-530-85-86  
 Email: [europe.support@nsc.com](mailto:europe.support@nsc.com)  
 Deutsch Tel: +49 (0) 69 9508 6208  
 English Tel: +49 (0) 870 24 0 2171  
 Français Tel: +33 (0) 1 41 91 8790

**National Semiconductor Asia Pacific Customer Support Center**  
 Email: [ap.support@nsc.com](mailto:ap.support@nsc.com)

**National Semiconductor Japan Customer Support Center**  
 Fax: 81-3-5639-7507  
 Email: [jpn.feedback@nsc.com](mailto:jpn.feedback@nsc.com)  
 Tel: 81-3-5639-7560