



ACST4 Series

ASD™ AC Switch Family

AC POWER SWITCH

MAIN APPLICATIONS

- AC static switching in appliance control systems
- Drive of low power high inductive or resistive loads like
 - spray pump in dishwashers
 - fan in air-conditioners

FEATURES

- Blocking voltage : $V_{DRM} / V_{RRM} = +/-700V$
- Avalanche controlled : $V_{CL\ typ} = 1100\ V$
- Nominal conducting current : $I_{T(RMS)} = 4A$
- High surge current capability: 30A for 20ms full wave
- Gate triggering current : $I_{GT} < 10\ mA$ or 25mA
- Switch integrated driver
- High noise immunity : static $dV/dt > 500V/\mu s$

BENEFITS

- Enables equipment to meet IEC 61000-4-5
- High off-state reliability with planar technology
- No external overvoltage protection needed
- Reduces the power component factor
- Interfaces directly with the microcontroller
- Direct interface with the microcontroller for the ACST4-7S ($I_{GT} < 10mA$)

DESCRIPTION

The ACST4 belongs to the AC power switch family built around the ASD™ technology. This high performance device is adapted to home appliances or industrial systems and drives loads up to 4 A.

The ACS™ switch embeds a Triac structure with a high voltage clamping device to absorb the inductive turn-off energy and withstand line transients such as those described in the IEC61000-4-5 standards.

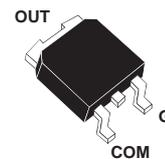

DPAK
ACST4-7SB/CB

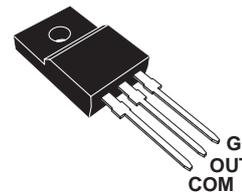

TO-220FPAB
ACST4-7SFP/CFP

FUNCTIONAL DIAGRAM

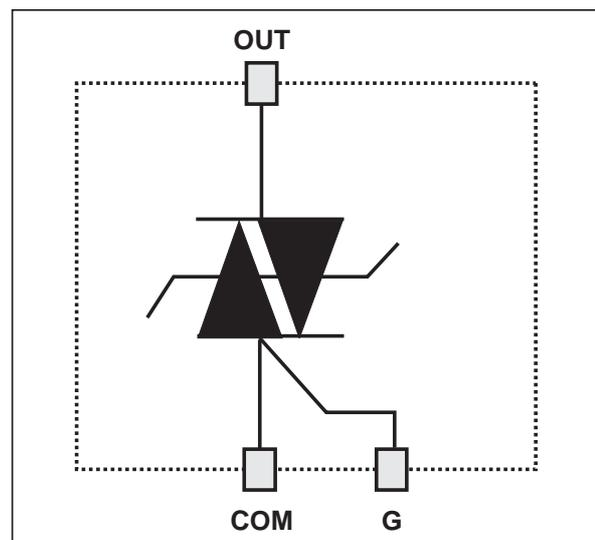

ACST4 Series

ABSOLUTE RATINGS (limiting values)

For either positive or negative polarity of pin OUT voltage in respect to pin COM voltage

Symbol	Parameter		Value	Unit	
V_{DRM} / V_{RRM}	Repetitive peak off-state voltage		$T_j = -10\text{ °C}$	700	V
$I_{T(RMS)}$	RMS on-state current full cycle sine wave 50 to 60 Hz	DPAK	$T_c = 110\text{ °C}$	4	A
		TO-220FPAB	$T_c = 100\text{ °C}$		
I_{TSM}	Non repetitive surge peak on-state current T_j initial = 25 °C , full cycle sine wave		$F = 50\text{ Hz}$	30	A
			$F = 60\text{ Hz}$	33	A
I^2t	Fusing capability		$t_p = 10\text{ ms}$	6.4	A^2s
di/dt	Repetitive on-state current critical rate of rise $I_G = 10\text{ mA}$ ($t_r < 100\text{ ns}$)	$T_j = 125\text{ °C}$	$F = 120\text{ Hz}$	50	$A/\mu s$
V_{PP}	Non repetitive line peak pulse voltage		note 1	2	kV
T_{stg}	Storage temperature range			- 40 to + 150	$^{\circ}\text{C}$
T_j	Operating junction temperature range			- 30 to + 125	$^{\circ}\text{C}$
T_l	Maximum lead soldering temperature during 10s			260	$^{\circ}\text{C}$

Note 1: according to test described by IEC61000-4-5 standard & Figure B.

GATE CHARACTERISTICS (maximum values)

Symbol	Parameter	Value	Unit
$P_{G(AV)}$	Average gate power dissipation	0.1	W
P_{GM}	Peak gate power dissipation ($t_p = 20\mu s$)	10	A
I_{GM}	Peak gate current ($t_p = 20\mu s$)	1	V

THERMAL RESISTANCES

Symbol	Parameter		Value	Unit
$R_{th(j-a)}$	Junction to ambient	$S = 0.5\text{ cm}^2$ DPAK	70	$^{\circ}\text{C/W}$
		TO-220FPAB	60	$^{\circ}\text{C/W}$
$R_{th(j-l)}$	Junction to case for full cycle sine wave conduction	DPAK	2.6	$^{\circ}\text{C/W}$
		TO-220FPAB	4.6	$^{\circ}\text{C/W}$

S = Copper surface under Tab

PARAMETER DESCRIPTION

Parameter Symbol	Parameter description
I_{GT}	Triggering gate current
V_{GT}	Triggering gate voltage
V_{GD}	Non-triggering gate voltage
I_H	Holding current
I_L	Latching current
V_{TM}	Peak on-state voltage drop
V_{TO}	On state threshold voltage
R_d	On state dynamic resistance
I_{DRM} / I_{RRM}	Maximum forward or reverse leakage current
dV/dt	Critical rate of rise of off-state voltage
$(dV/dt)_c$	Critical rate of rise of commutating off-state voltage
$(dI/dt)_c$	Critical rate of decrease of commutating on-state current
V_{CL}	Clamping voltage
I_{CL}	Clamping current

ELECTRICAL CHARACTERISTICS

For either positive or negative polarity of pin OUT voltage in respect to pin COM voltage.

Symbol	Test Conditions				ACST4-7S	ACST4-7C	Unit
I_{GT}	$V_{OUT}=12V$ (DC) $R_L=33\Omega$	QI - QII - QIII	$T_j=25^\circ C$	MAX	10	25	mA
V_{GT}	$V_{OUT}=12V$ (DC) $R_L=33\Omega$	QI - QII - QIII	$T_j=25^\circ C$	MAX	1	1.1	V
V_{GD}	$V_{OUT}=V_{DRM}$ $R_L=3.3k\Omega$		$T_j=125^\circ C$	MIN	0.2		V
I_H	$I_{OUT}=100mA$ gate open		$T_j=25^\circ C$	MAX	20	35	mA
I_L	$I_G=2 \times I_{GTmax}$		$T_j=25^\circ C$	MAX	40	60	mA
V_{TM}	$I_{OUT}=5.6A$ $t_p=380\mu s$		$T_j=25^\circ C$	MAX	1.5		V
V_{TO}			$T_j=125^\circ C$	MAX	0.90		V
R_d			$T_j=125^\circ C$	MAX	100		m Ω
I_{DRM} / I_{RRM}	$V_{OUT}=700V$		$T_j=25^\circ C$	MAX	10		μA
			$T_j=125^\circ C$	MAX	500		
dV/dt	$V_{OUT}=460V$ gate open		$T_j=110^\circ C$	MIN	200	500	V/ μs
$(dI/dt)_c$	$(dV/dt)_c=15V/\mu s$		$T_j=125^\circ C$	MIN	2.0	2.5	A/ms
V_{CL}	$I_{CL}=1mA$ $t_p=1ms$		$T_j=25^\circ C$	TYP	1100		V

ACST4 Series

AC LINE SWITCH BASIC APPLICATION

The ACST4 device has been designed to switch on & off low power, but highly inductive or resistive loads such as dishwashers spray pumps, and air-conditioners fan.

Pin COM: Common drive reference to connect to the power line neutral

Pin G: Switch Gate input to connect to the digital controller

Pin OUT: Switch Output to connect to the load

ACST4-7S triggering current has to be sunk from the gate pin G. The switch can then be driven directly by logic level circuits through a resistor as shown on the typical application diagram (Fig A).

Thanks to its thermal and turn off commutation performances, the ACST4 switch is able to drive with no turn off additional snubber an inductive load up to 4 A.

TYPICAL APPLICATION DIAGRAM (Fig. A)

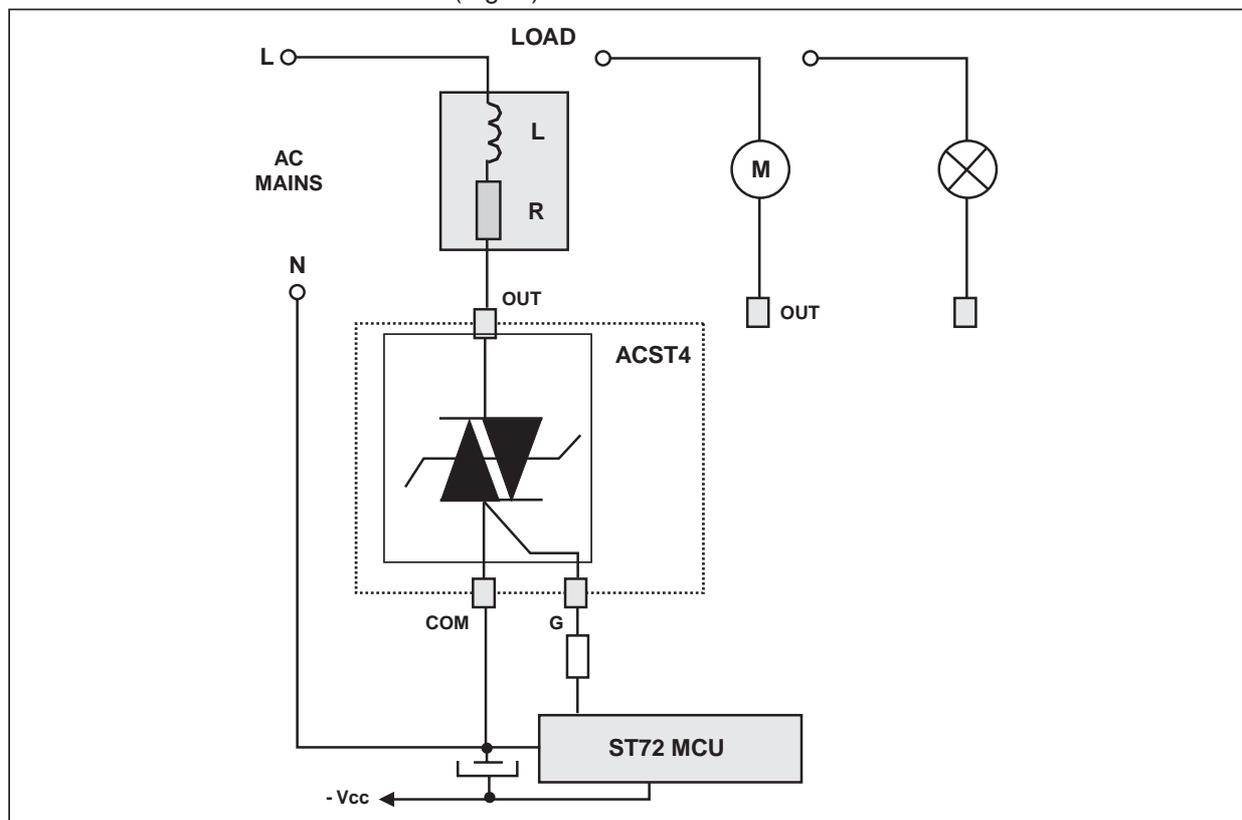

AC LINE TRANSIENT VOLTAGE RUGGEDNESS

The ACST4 switch is able to sustain safely the AC line transient voltages either by clamping the low energy spikes or by breaking over under high energy shocks, even with high turn-on current rises.

The test circuit of the figure 2 is representative of the final ACST application and is also used to stress the ACST switch according to the IEC 61000-4-5 standard conditions. Thanks to the load, the ACST switch sustains the voltage spikes up to 2 kV above the peak line voltage. It will break over safely even on resistive load where the turn on current rate of rise, is as high as shown on figure 3. Such non-repetitive test can be done 10 times on each AC line voltage polarity.

Fig. B: Overvoltage ruggedness test circuit for resistive and inductive loads according to IEC61000-4-5 standards.
 $R = 150\Omega$, $L = 10\mu\text{H}$, $V_{PP} = 2\text{kV}$.

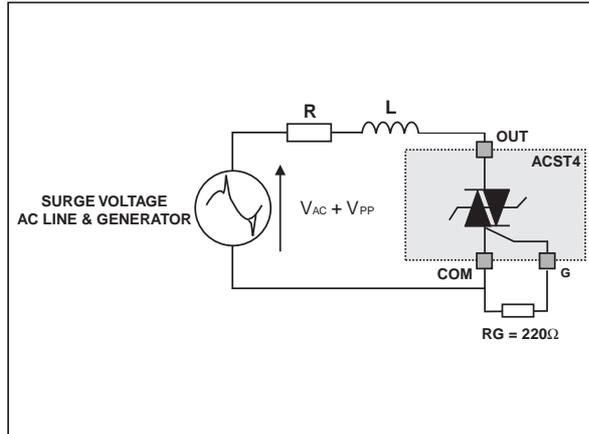

Fig. C: Current and Voltage of the ACST4 during IEC61000-4-5 standard test with R, L & V_{PP} .

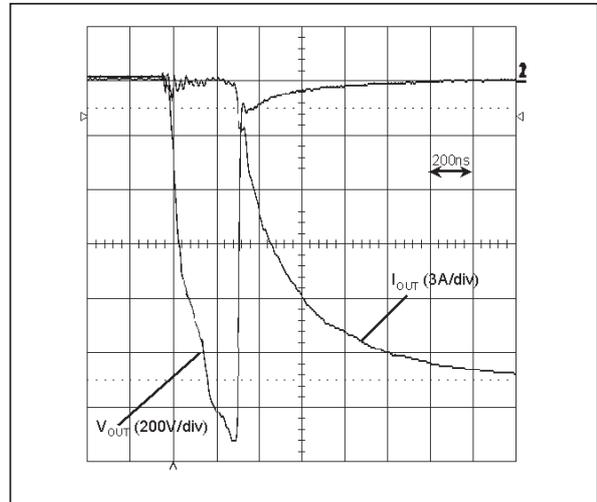

Fig. 1: Maximum power dissipation versus RMS on-state current.

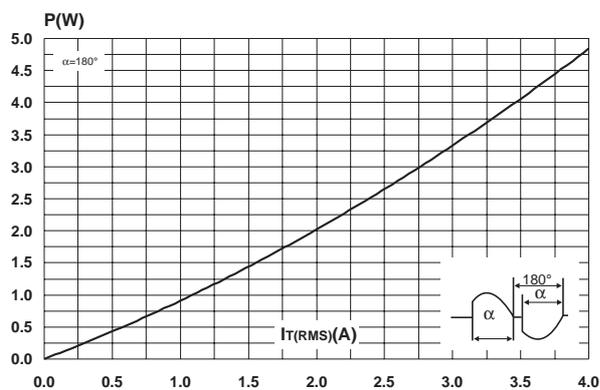

Fig. 2-1: RMS on-state current versus case temperature.

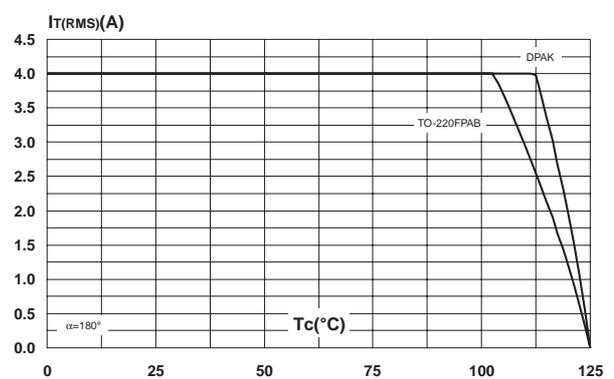

Fig. 2-2: RMS on-state current versus ambient temperature.

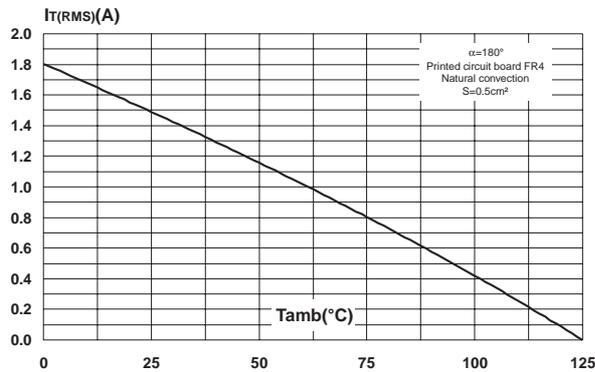

Fig. 3: Relative variation of thermal impedance versus pulse duration.

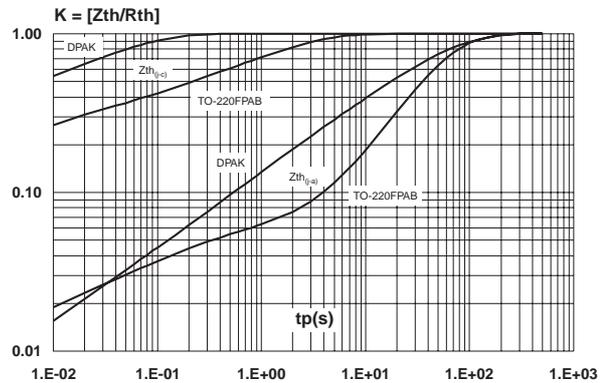

Fig. 4: Relative variation of gate trigger current, holding current and latching versus junction temperature (typical values).

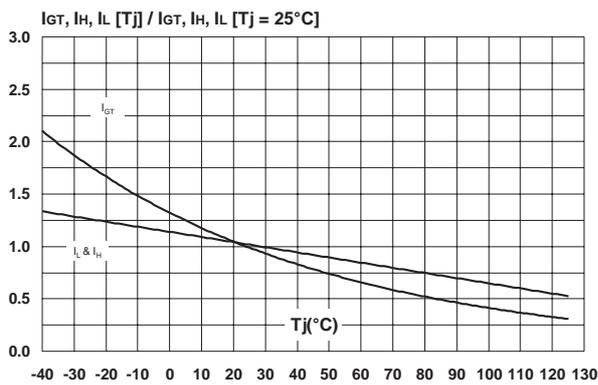

Fig. 5: Relative variation of static dV/dt versus junction temperature.

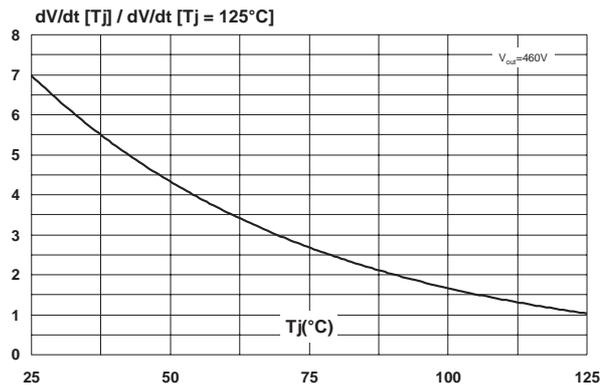

Fig. 6-1: Relative variation of critical rate of decrease of main current versus reapplied dV/dt (typical values).

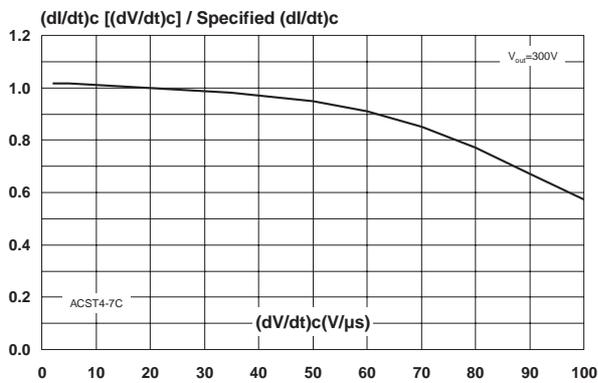

Fig. 6-2: Relative variation of critical rate of decrease of main current versus reapplied dV/dt (typical values).

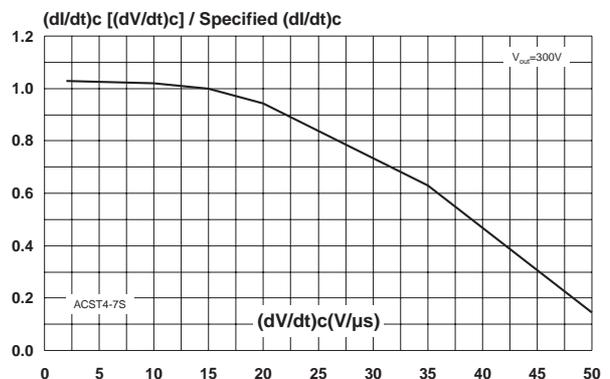

Fig. 7: Relative variation of critical rate of decrease of main current versus junction temperature.

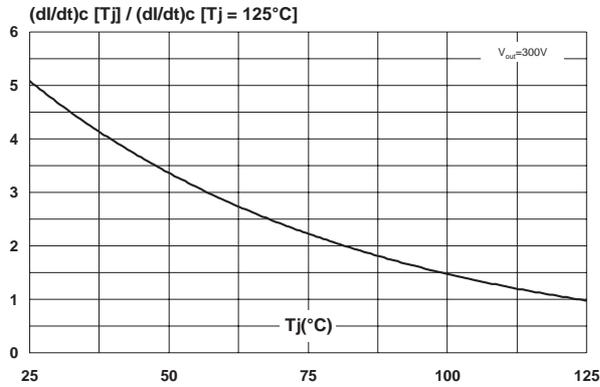

Fig. 8: Surge peak on-state current versus number of cycles.

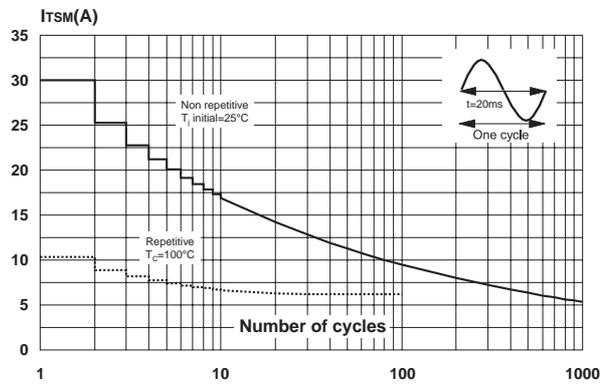

Fig. 9: Non repetitive surge peak on-state current for a sinusoidal pulse with width $t_p < 10\text{ms}$, and corresponding value of I^2t .

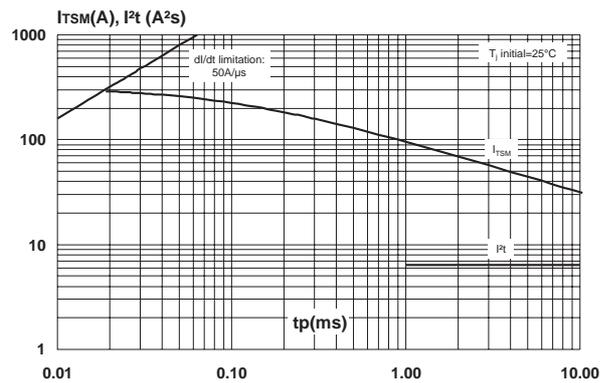

Fig. 10: On-state characteristics (maximum values).

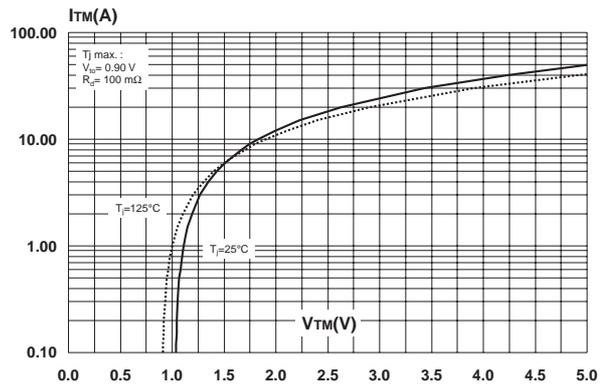
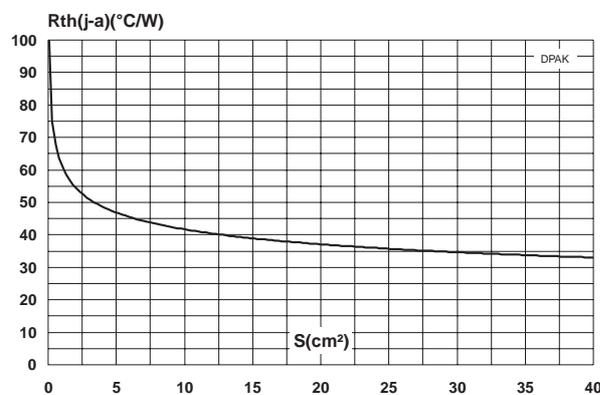
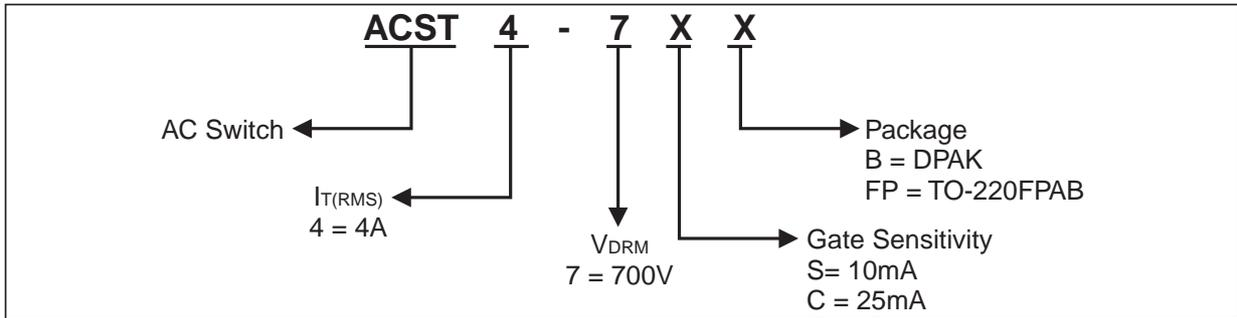

Fig. 11: Thermal resistance junction to ambient versus copper surface under tab (printed circuit board FR4, copper thickness: 35µm)



ACST4 Series

ORDERING INFORMATION



PACKAGE OUTLINE MECHANICAL DATA DPAK

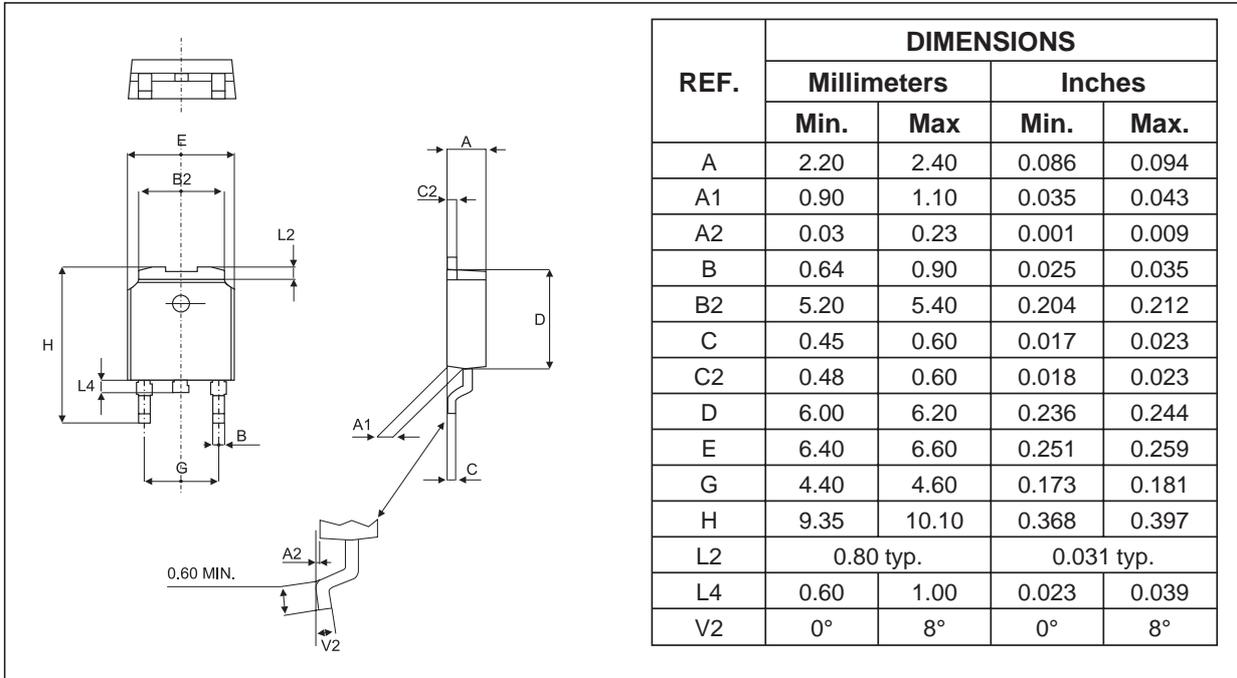

FOOT PRINT DPAK

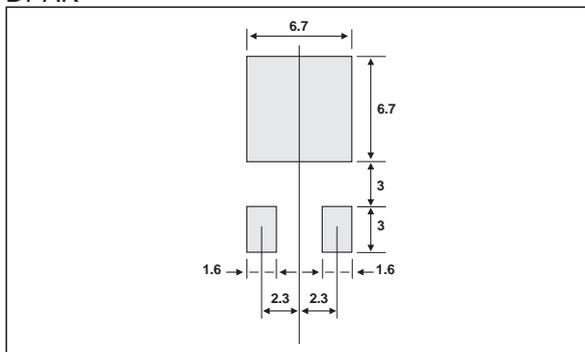

PACKAGE OUTLINE MECHANICAL DATA
TO-220FPAB

REF.	DIMENSIONS			
	Millimeters		Inches	
	Min.	Max.	Min.	Max.
A	4.4	4.6	0.173	0.181
B	2.5	2.7	0.098	0.106
D	2.5	2.75	0.098	0.108
E	0.45	0.70	0.018	0.027
F	0.75	1	0.030	0.039
F1	1.15	1.70	0.045	0.067
F2	1.15	1.70	0.045	0.067
G	4.95	5.20	0.195	0.205
G1	2.4	2.7	0.094	0.106
H	10	10.4	0.393	0.409
L2	16 Typ.		0.63 Typ.	
L3	28.6	30.6	1.126	1.205
L4	9.8	10.6	0.386	0.417
L5	2.9	3.6	0.114	0.142
L6	15.9	16.4	0.626	0.646
L7	9.00	9.30	0.354	0.366

OTHER INFORMATION

Ordering type	Marking	Package	Weight	Base qty	Delivery mode
ACST4-7SB	ACST47S	DPAK	0.3 g	75	Tube
ACST4-7SB-TR	ACST47S	DPAK	0.3 g	2500	Tape & reel
ACST4-7SFP	ACST47S	TO-220FPAB	2.4 g	50	Tube
ACST4-7CB	ACST47C	DPAK	0.3 g	75	Tube
ACST4-7CB-TR	ACST47C	DPAK	0.3 g	2500	Tape & reel
ACST4-7CFP	ACST47C	TO-220FPAB	2.4 g	50	Tube

- Epoxy meets UL94,V0

Information furnished is believed to be accurate and reliable. However, STMicroelectronics assumes no responsibility for the consequences of use of such information nor for any infringement of patents or other rights of third parties which may result from its use. No license is granted by implication or otherwise under any patent or patent rights of STMicroelectronics. Specifications mentioned in this publication are subject to change without notice. This publication supersedes and replaces all information previously supplied. STMicroelectronics products are not authorized for use as critical components in life support devices or systems without express written approval of STMicroelectronics.

The ST logo is a registered trademark of STMicroelectronics

© 2003 STMicroelectronics - Printed in Italy - All rights reserved.

STMicroelectronics GROUP OF COMPANIES

Australia - Brazil - Canada - China - Finland - France - Germany
 Hong Kong - India - Israel - Italy - Japan - Malaysia - Malta - Morocco - Singapore
 Spain - Sweden - Switzerland - United Kingdom - United States.

<http://www.st.com>

