



# SFA1601G THRU SFA1608G

16.0 AMPS. Glass Passivated Super Fast Rectifiers



Voltage Range  
50 to 600 Volts  
Current  
16.0 Amperes

## Features

- ✧ Low forward voltage drop
- ✧ High current capability
- ✧ High reliability
- ✧ High surge current capability

## Mechanical Data

- ✧ Cases: Molded plastic
- ✧ Epoxy: UL 94V-O rate flame retardant
- ✧ Terminals: Leads solderable per MIL-STD-202, Method 208 guaranteed
- ✧ Polarity: As marked
- ✧ High temperature soldering guaranteed: 260°C/10 seconds .16", (4.06mm) from case.
- ✧ Weight: 2.24 grams

## TO-220A

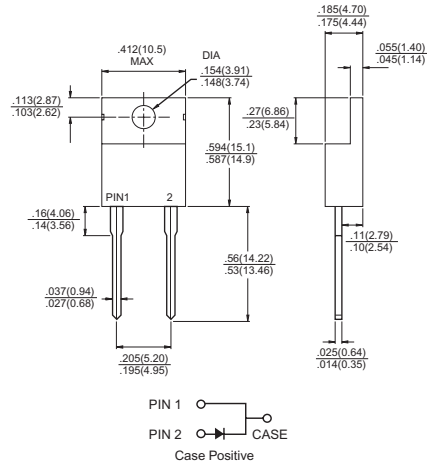

Dimensions in inches and (millimeters)

## Maximum Ratings and Electrical Characteristics

Rating at 25°C ambient temperature unless otherwise specified.

Single phase, half wave, 60 Hz, resistive or inductive load.

For capacitive load, derate current by 20%

Type Number	Symbol	SFA 1601G	SFA 1602G	SFA 1603G	SFA 1604G	SFA 1605G	SFA 1606G	SFA 1607G	SFA 1608G	Units
Maximum Recurrent Peak Reverse Voltage	$V_{RRM}$	50	100	150	200	300	400	500	600	V
Maximum RMS Voltage	$V_{RMS}$	35	70	105	140	210	280	350	420	V
Maximum DC Blocking Voltage	$V_{DC}$	50	100	150	200	300	400	500	600	V
Maximum Average Forward Rectified Current @ $T_C = 100^\circ\text{C}$	$I_{(AV)}$	16.0								A
Peak Forward Surge Current, 8.3 ms Single Half Sine-wave Superimposed on Rated Load (JEDEC method)	$I_{FSM}$	200								A
Maximum Instantaneous Forward Voltage @ 16.0A	$V_F$	0.975			1.3		1.7			V
Maximum DC Reverse Current @ $T_A=25^\circ\text{C}$ at Rated DC Blocking Voltage @ $T_A=100^\circ\text{C}$	$I_R$	10				400				uA uA
Maximum Reverse Recovery Time (Note 1)	$T_{rr}$	35								nS
Typical Junction Capacitance (Note 2)	$C_j$	130				100				pF
Typical Thermal Resistance (Note 3)	$R_{\theta_{JC}}$	1.0								°C/W
Operating Temperature Range	$T_J$	-65 to +150								°C
Storage Temperature Range	$T_{STG}$	-65 to +150								°C

Notes: 1. Reverse Recovery Test Conditions:  $I_F=0.5A$ ,  $I_R=1.0A$ ,  $I_{RR}=0.25A$

2. Measured at 1 MHz and Applied Reverse Voltage of 4.0 V D.C.

3. Mounted on Heatsink. Size of 3 in x 5 in x 0.25 in Al-Plate.

## RATINGS AND CHARACTERISTIC CURVES (SFA1601G THRU SFA1608G)

FIG. 1- REVERSE RECOVERY TIME CHARACTERISTIC AND TEST CIRCUIT DIAGRAM

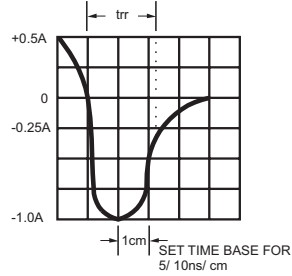
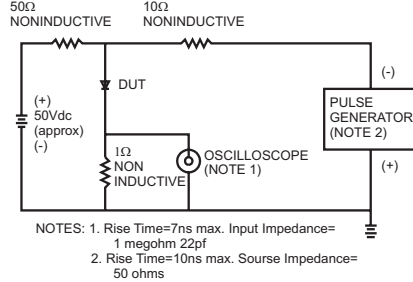

FIG.2- MAXIMUM FORWARD CURRENT DERATING CURVE

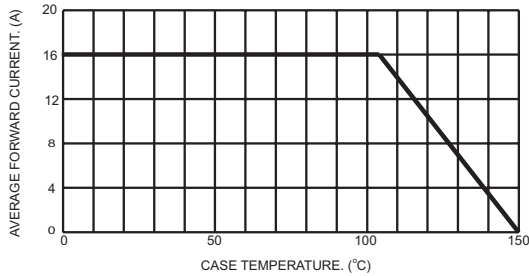

FIG.3- TYPICAL REVERSE CHARACTERISTICS

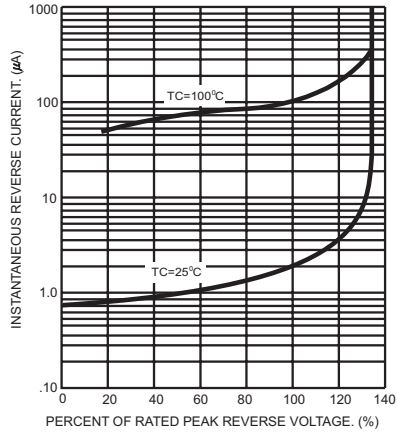

FIG.4- MAXIMUM NON-REPETITIVE FORWARD SURGE CURRENT

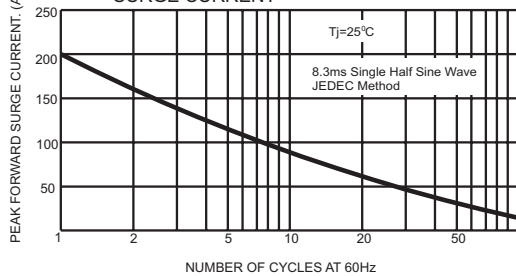

FIG.6- TYPICAL FORWARD CHARACTERISTICS

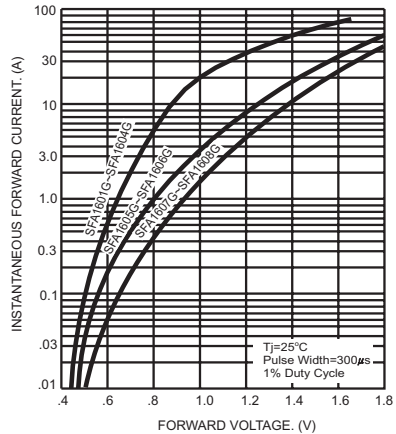
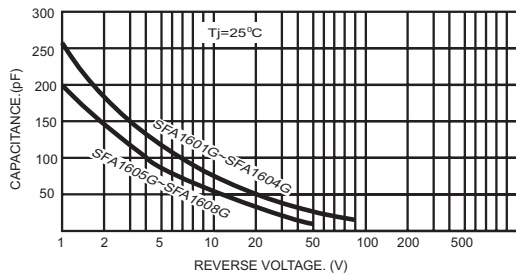

FIG.5- TYPICAL JUNCTION CAPACITANCE



This datasheet has been download from:

[www.datasheetcatalog.com](http://www.datasheetcatalog.com)

Datasheets for electronics components.